

Ø10mm
45 G-90 1F

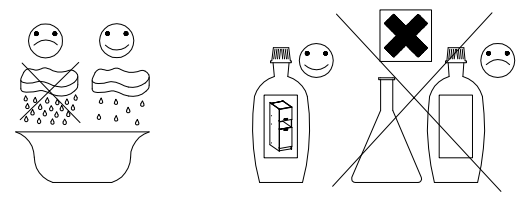

max.
5kg

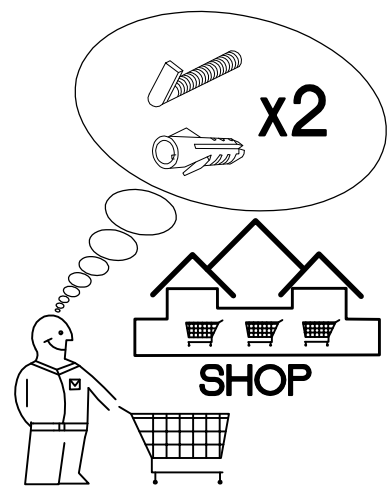
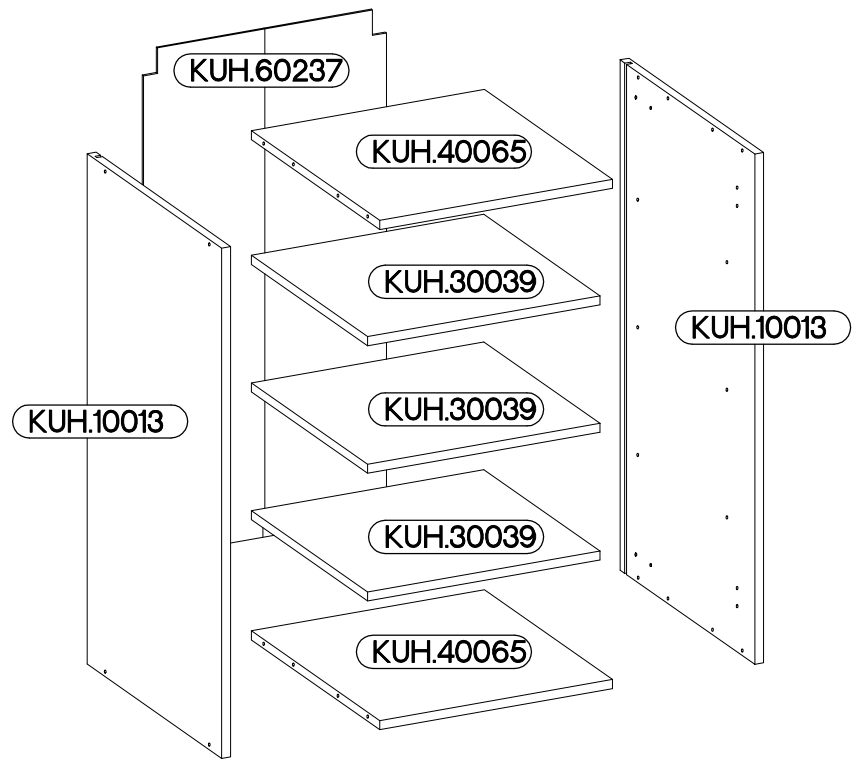
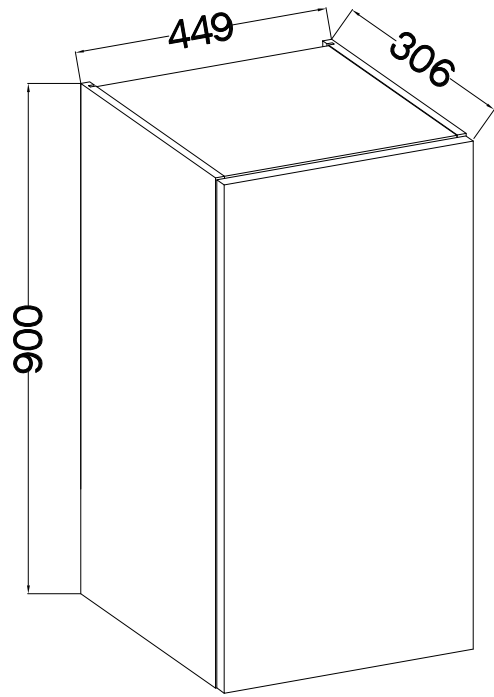
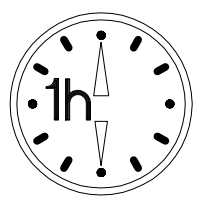

KUH.30039
KUH.40065

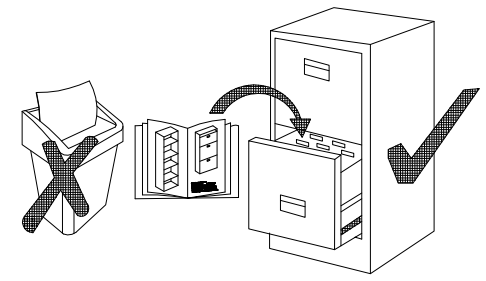

 8x30mm A 8	 6,4 x 50mm B 8	 E1 8	 35/0mm HG 2	 5/19mm J 12	 K 2	 O 1	 3.5x13mm P5 4	 3.0x20mm P7 8-10	 4.0x30mm P8 4
-------------------------------------------	-----------------------------------------------	---------------------------	--------------------------------------------	--------------------------------------------	--------------------------	--------------------------	----------------------------------------------	-------------------------------------------------	----------------------------------------------



ISM-KUH-01123

 +8x30mm A	 +4.0x30mm P8	 K
8	4	2

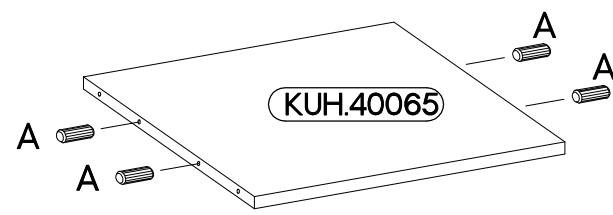
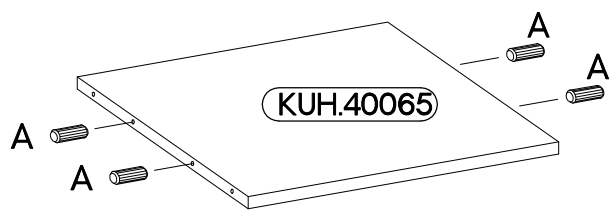
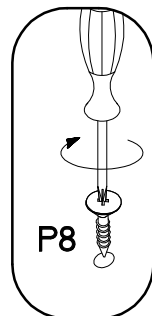
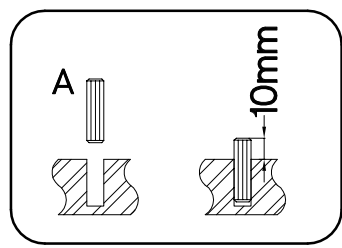
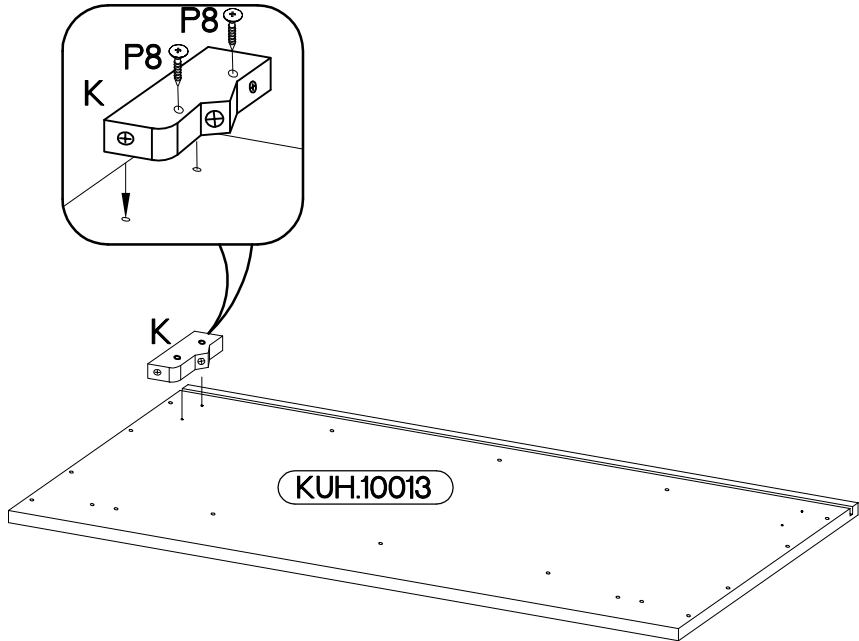
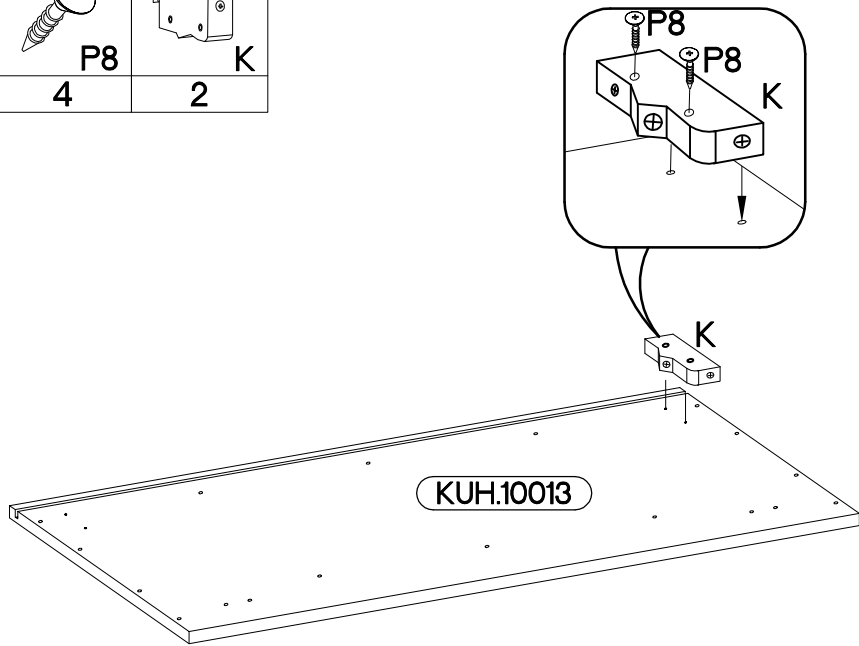
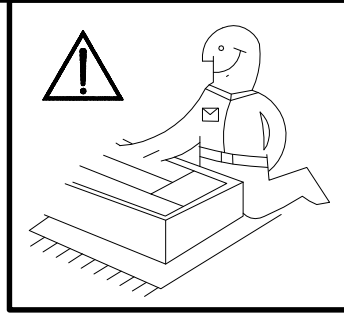

2

6,4 x 50mm

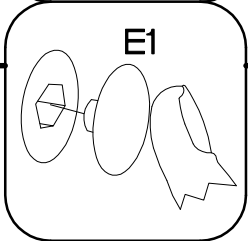
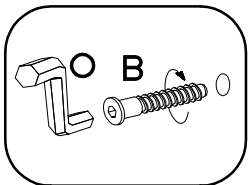
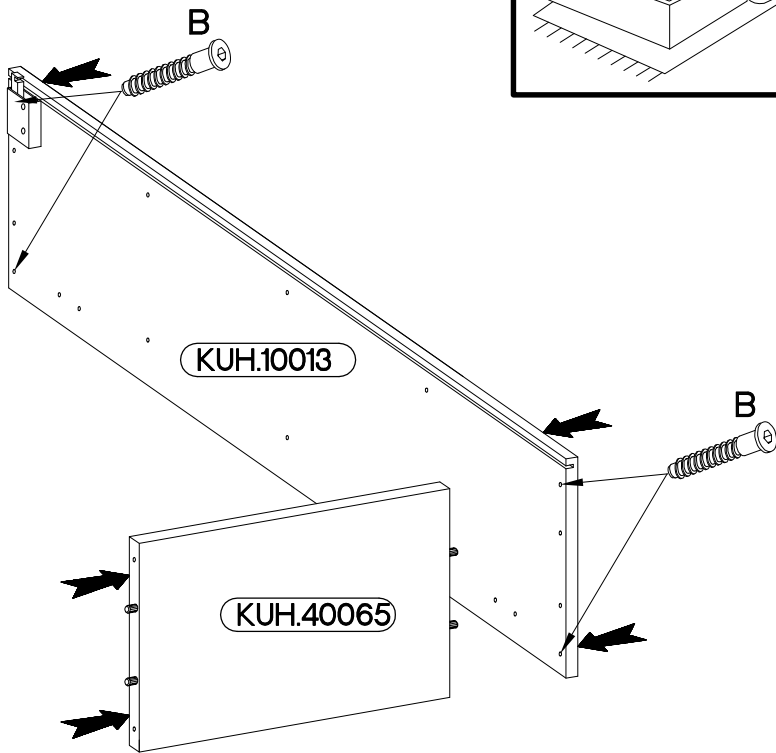
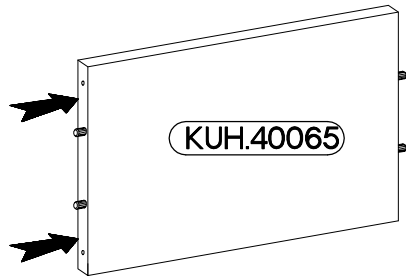
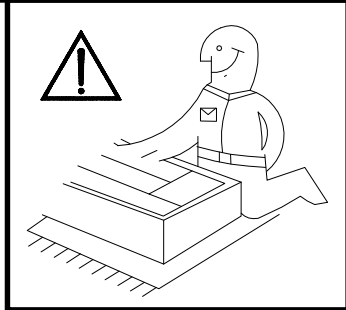
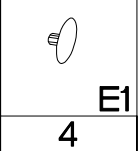
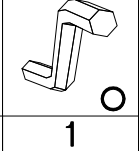
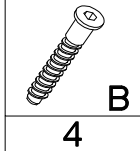

3

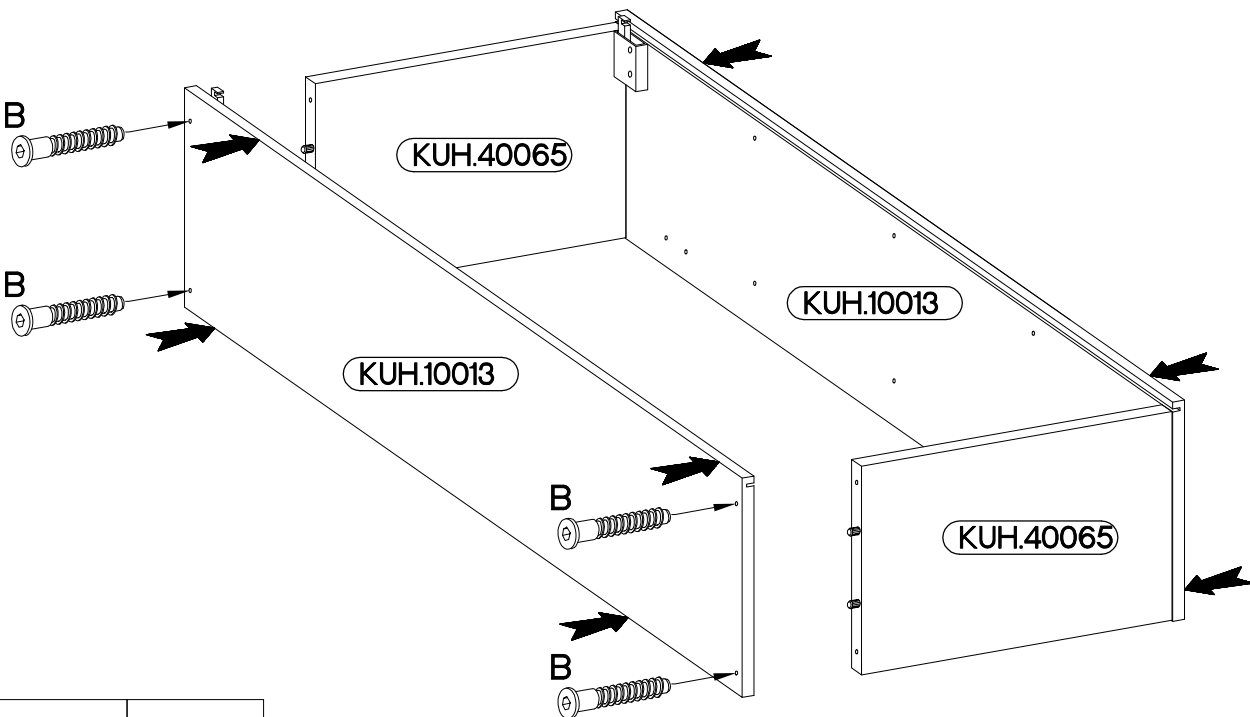

6,4 x 50mm

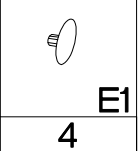
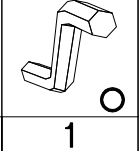
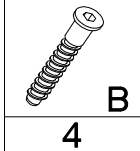

4

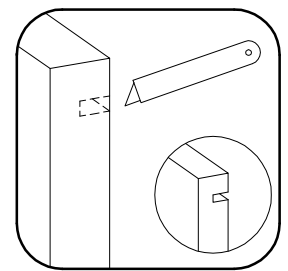
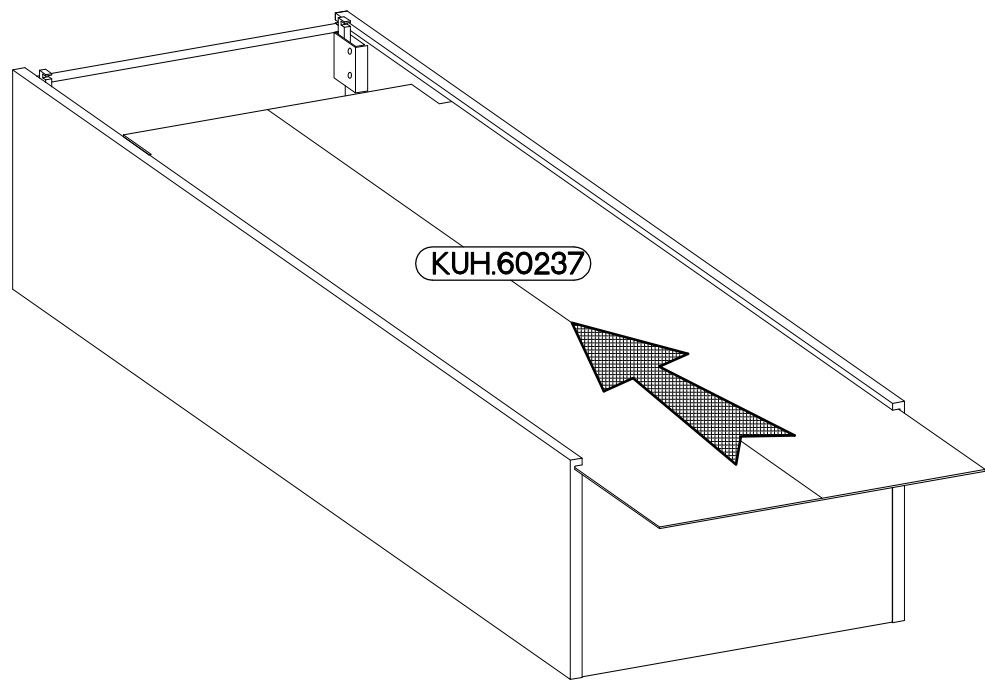
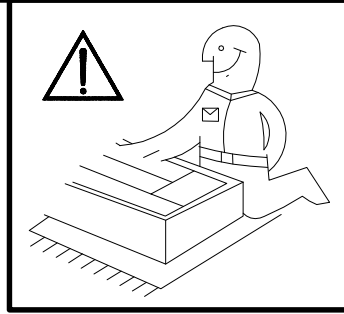

5

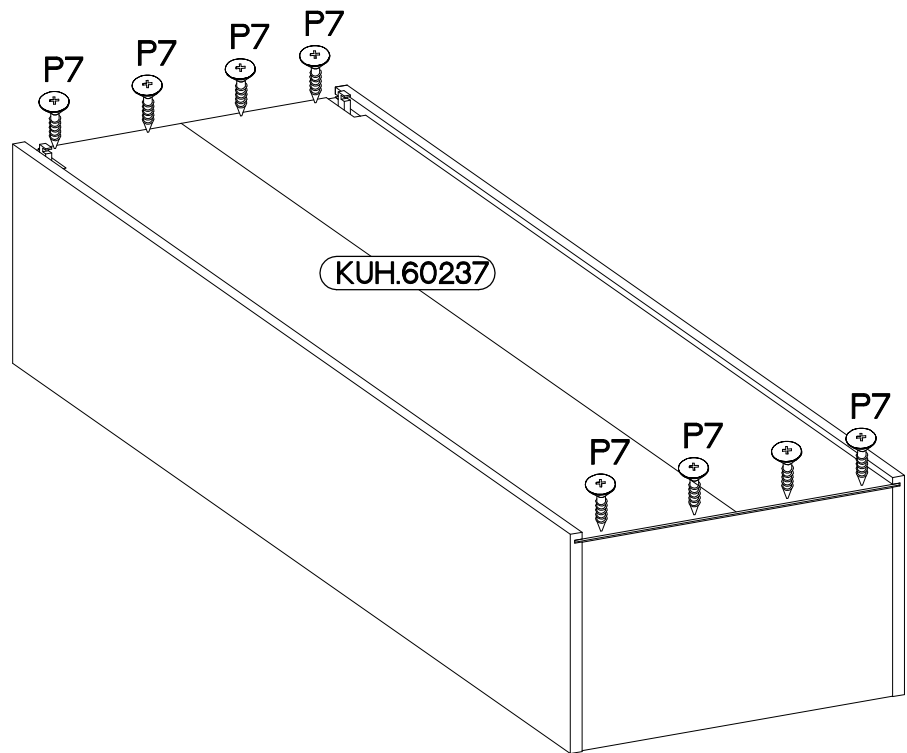
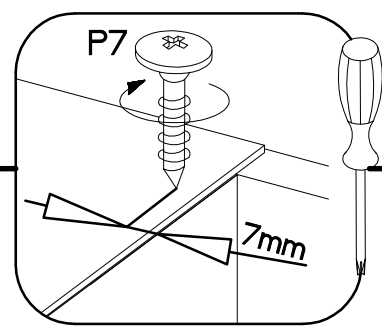
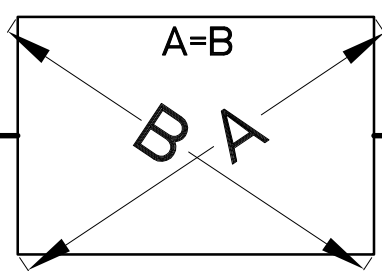
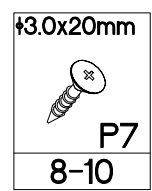

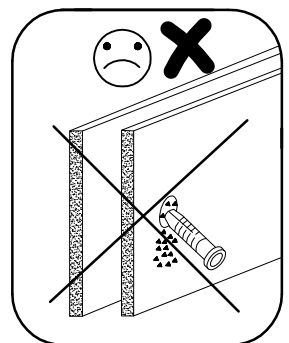
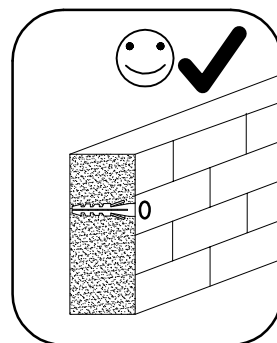
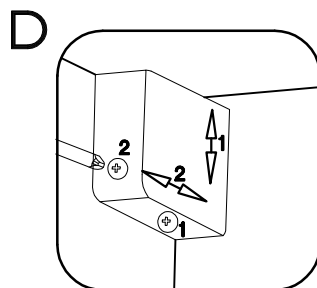
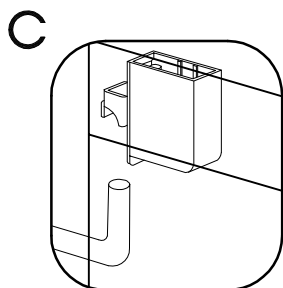
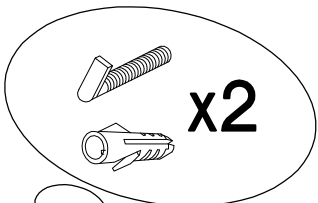
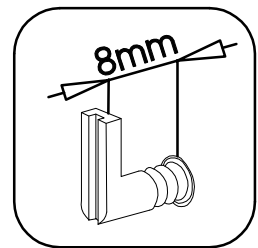
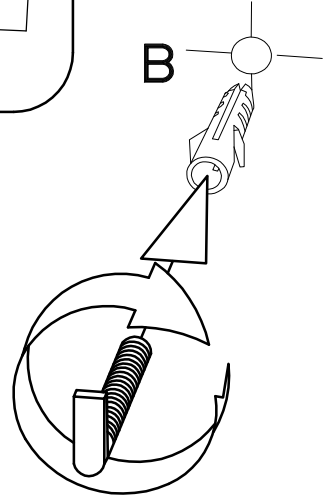
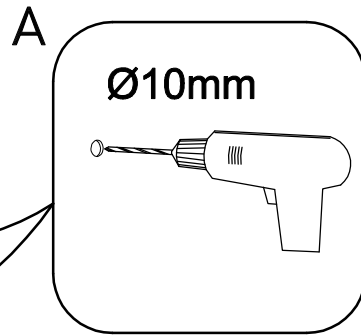
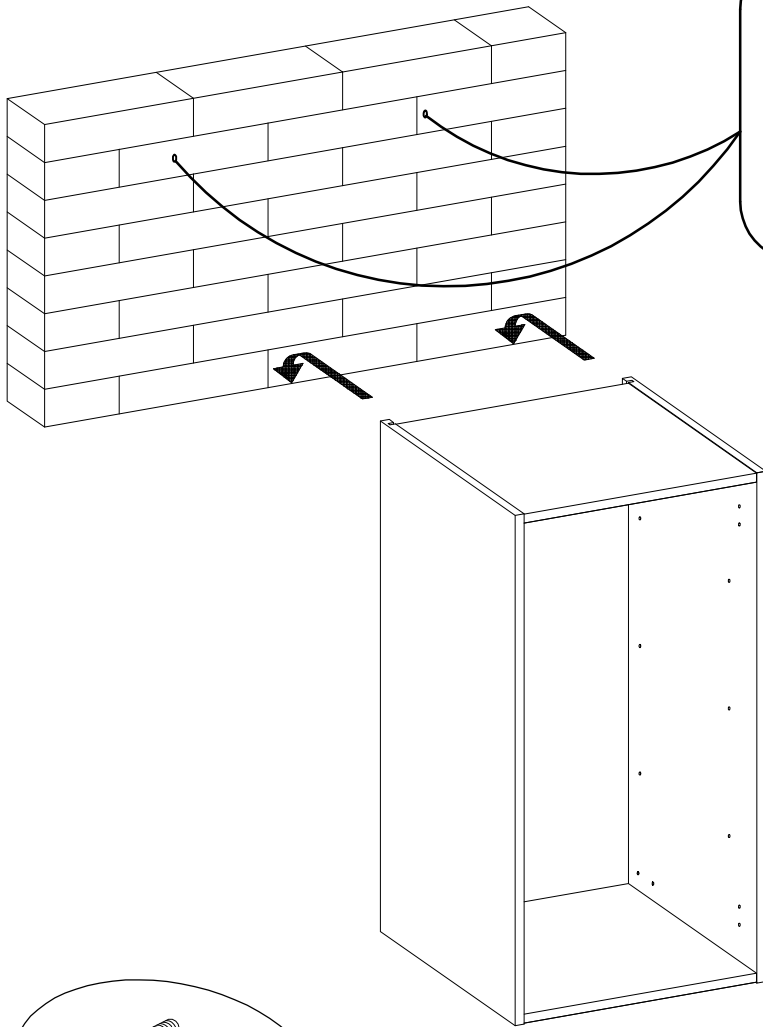
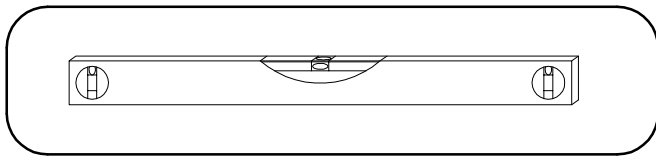

7

±5/19mm
J
12

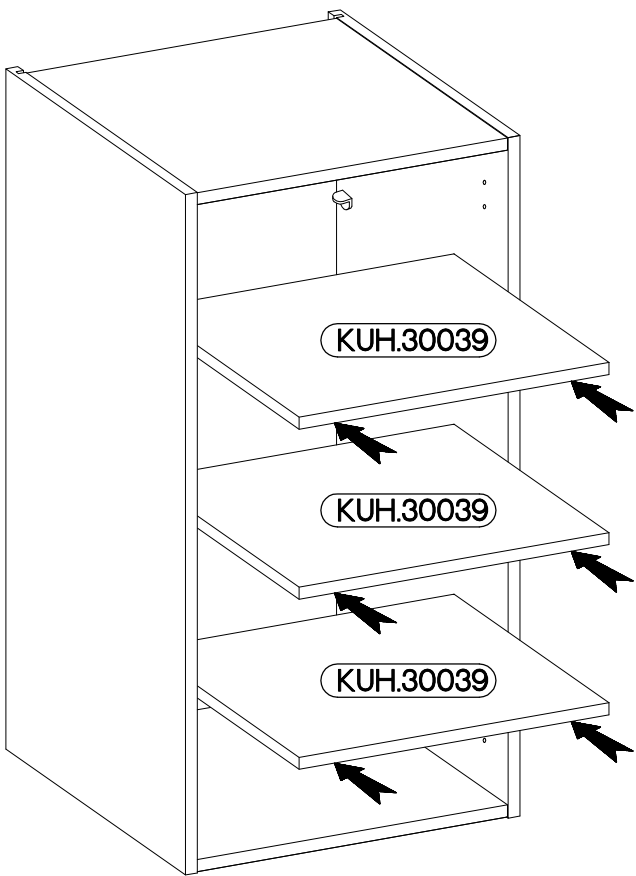
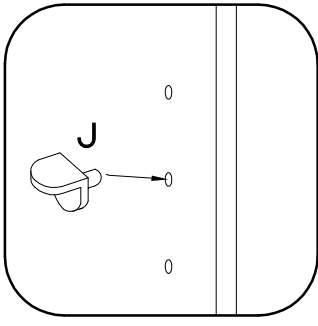

8

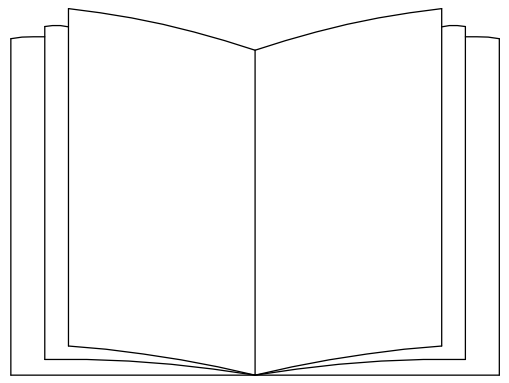
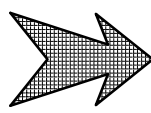
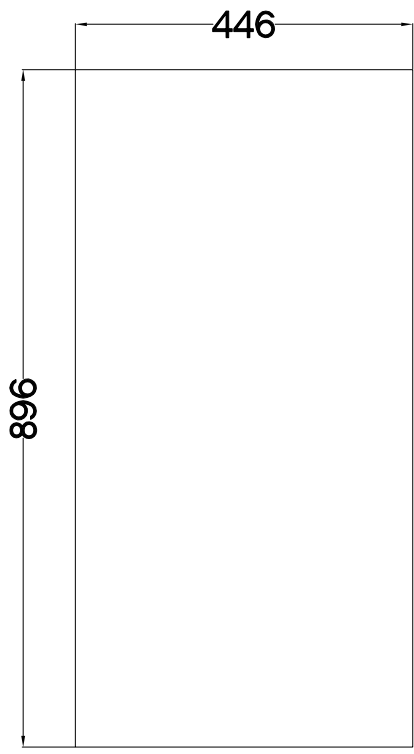

FRONT

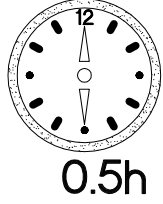
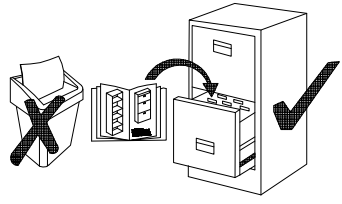
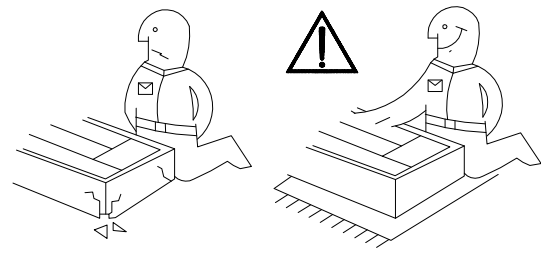
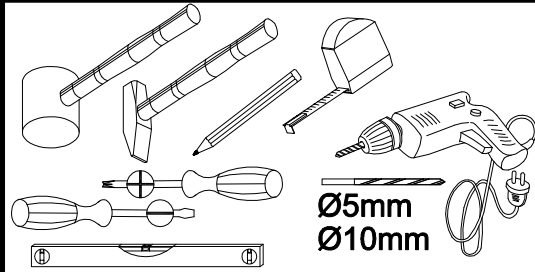
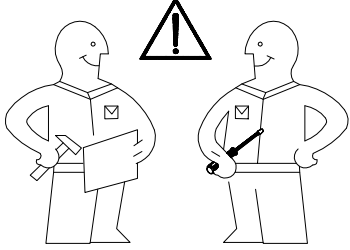

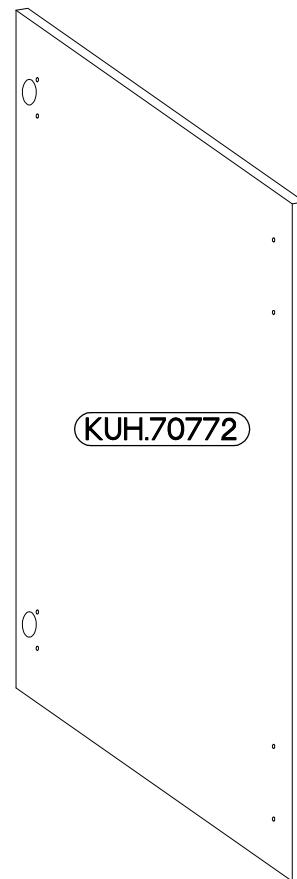
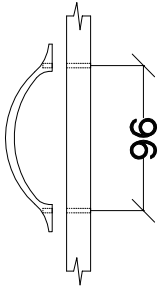
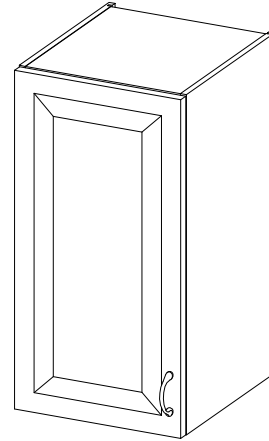
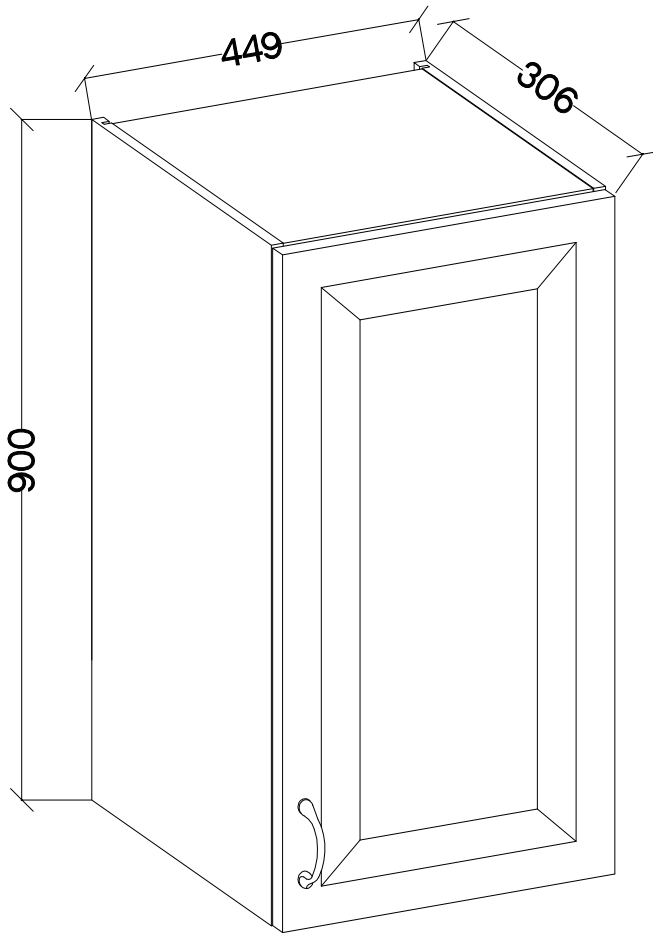
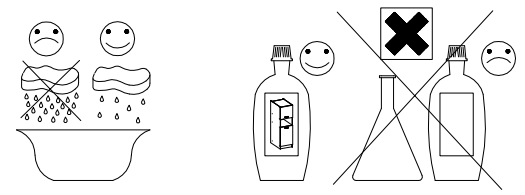

45 G-90 1F
FRONT



M4x22mm	
	
U	S
2	1

ISM-KUH-01188



1

LEFT

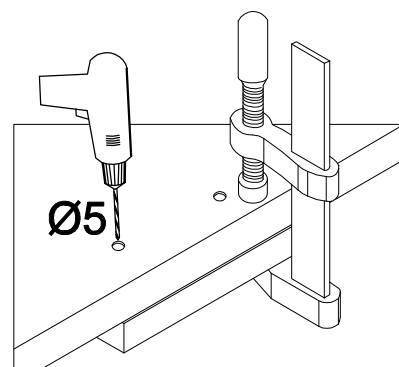
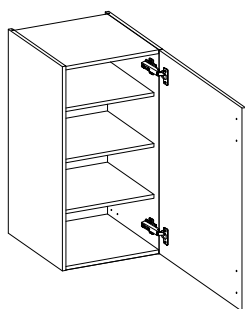
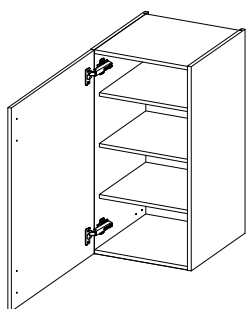
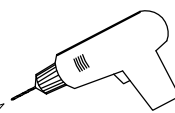
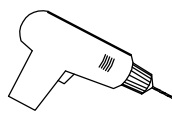
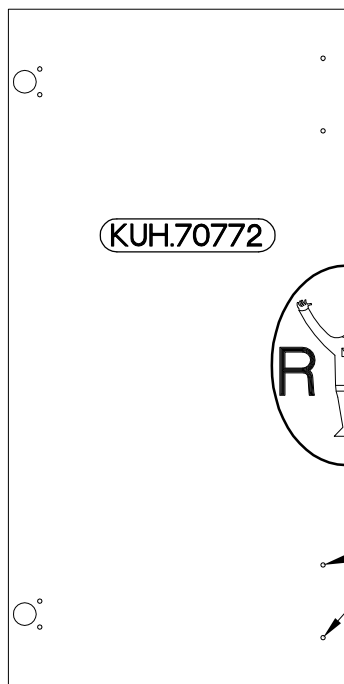
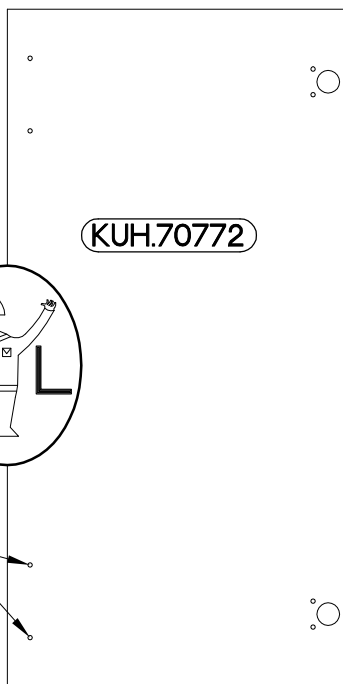
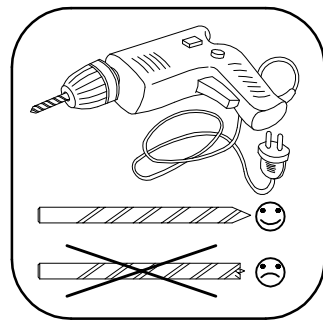
RIGHT



2

 HG 2	 P5 4
------------------------------------------------------------------------------------------------	------------------------------------------------------------------------------------------------

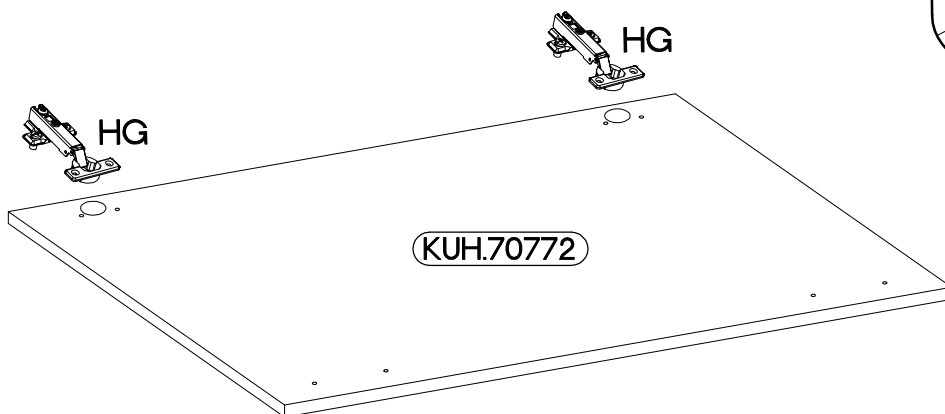
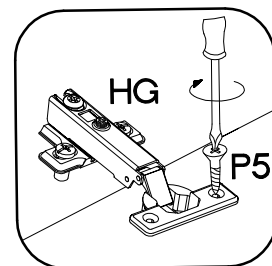

M4x22mm

