

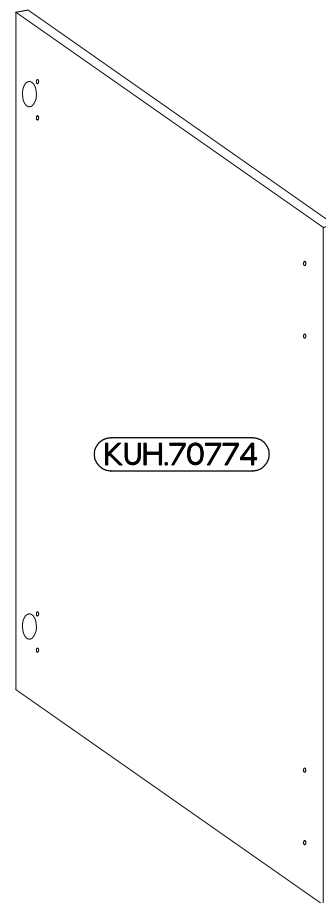

0.5h

50 G-90 1F

FRONT

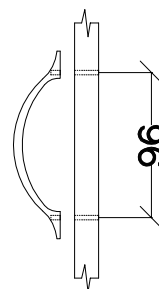
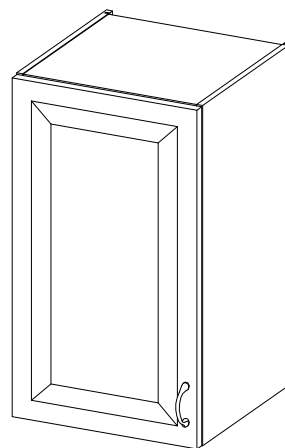
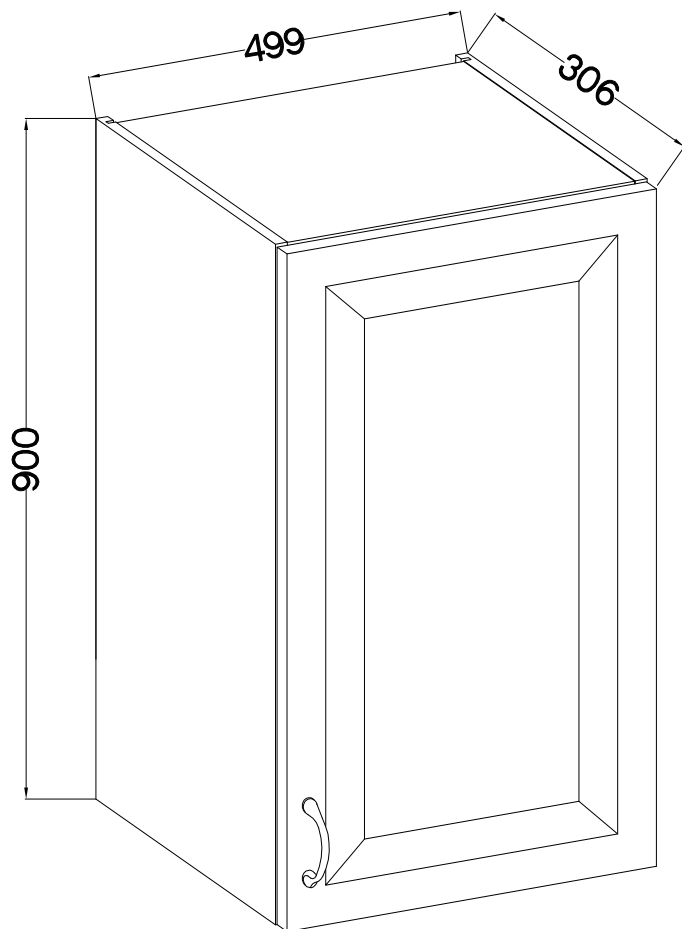
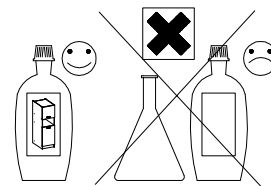

M4x22mm	
	
U	S
2	1

ISM-KUH-01190



1

LEFT

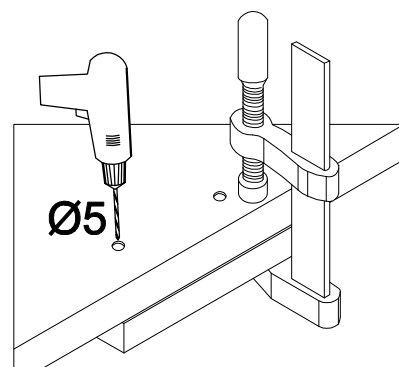
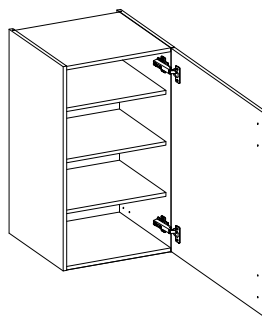
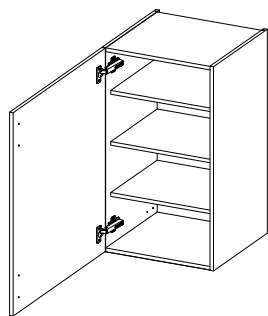
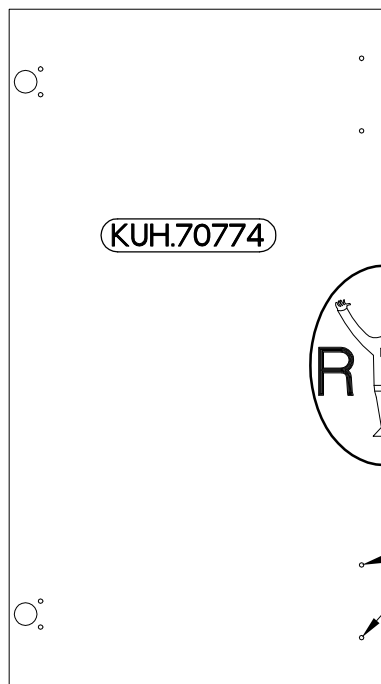
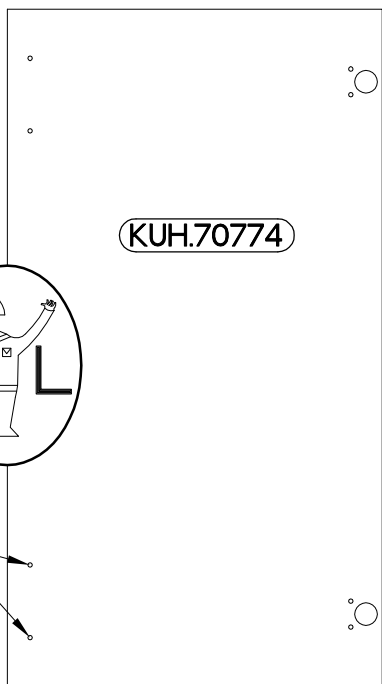
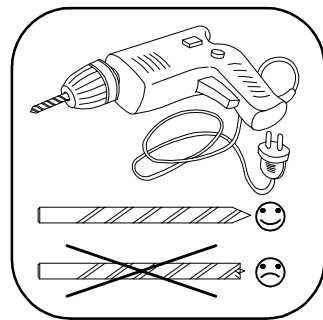
RIGHT



2

 HG 2	 P5 4
--	--

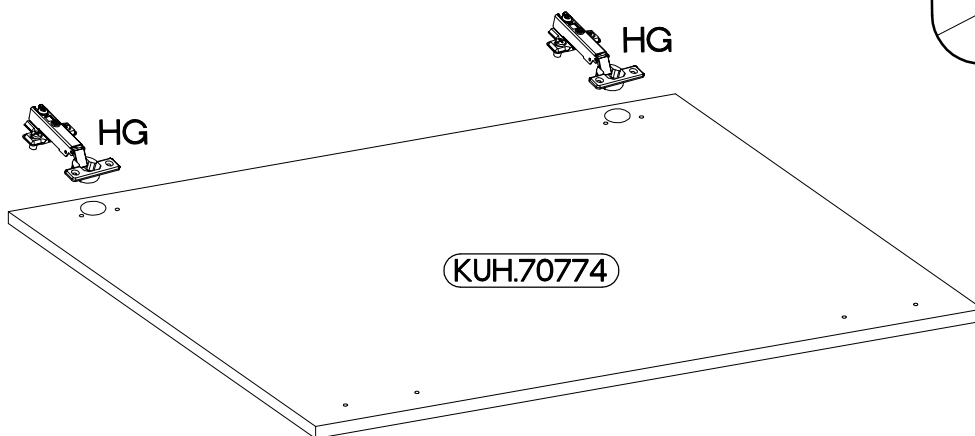
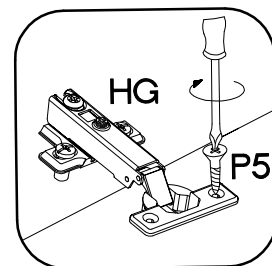

3

M4x22mm



U

2

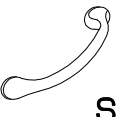

S

1

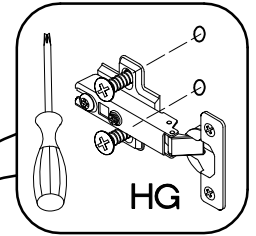

HG

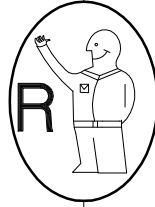

R

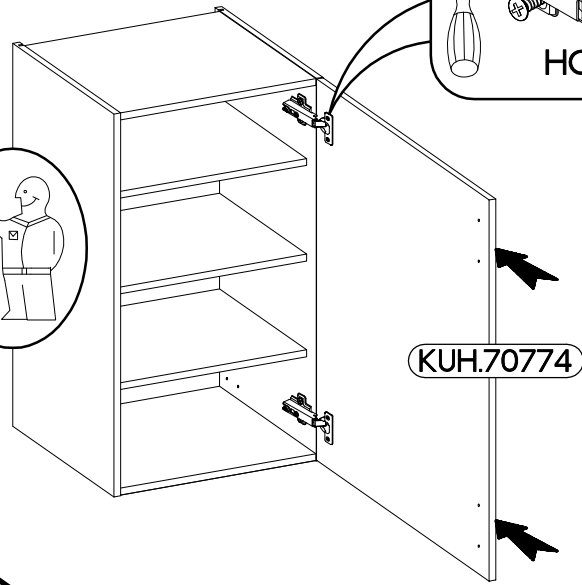

KUH.70774

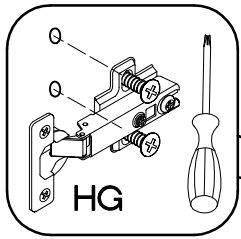

HG

KUH.70774

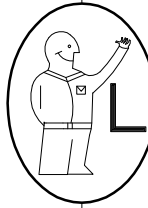
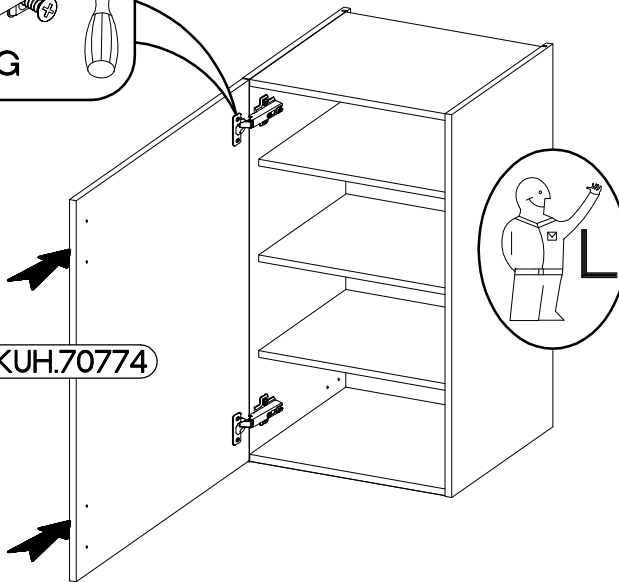

L

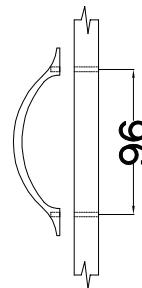

96

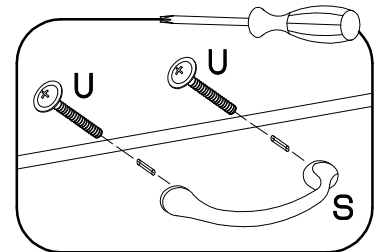

U

S

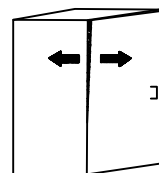
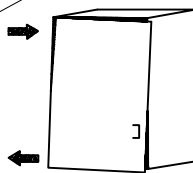
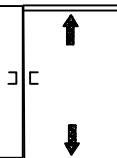
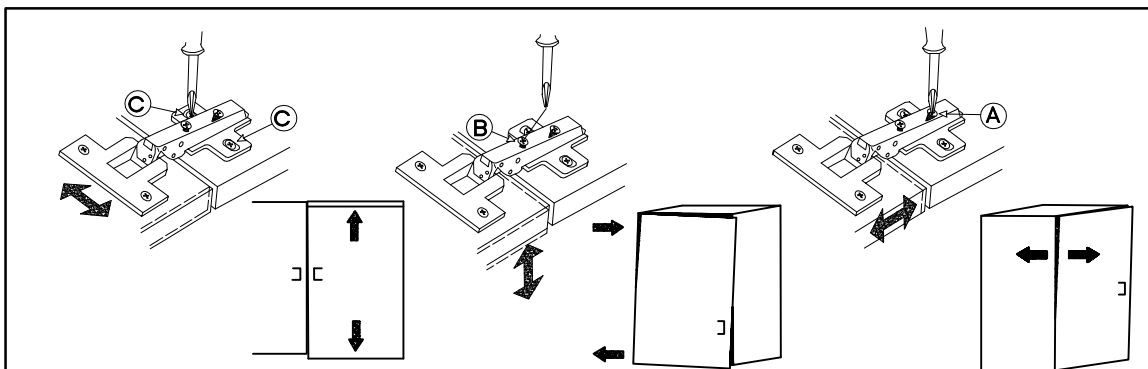

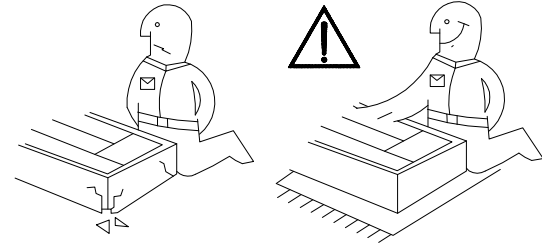
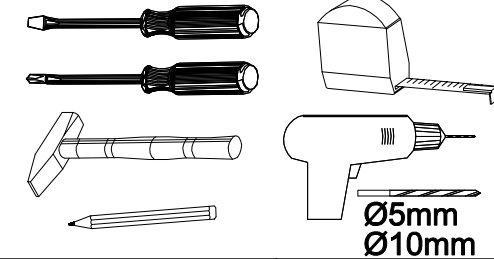
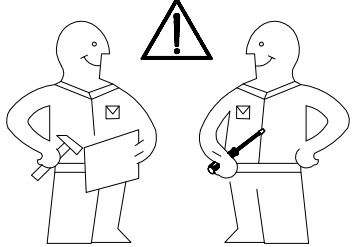

50 G-90 1F

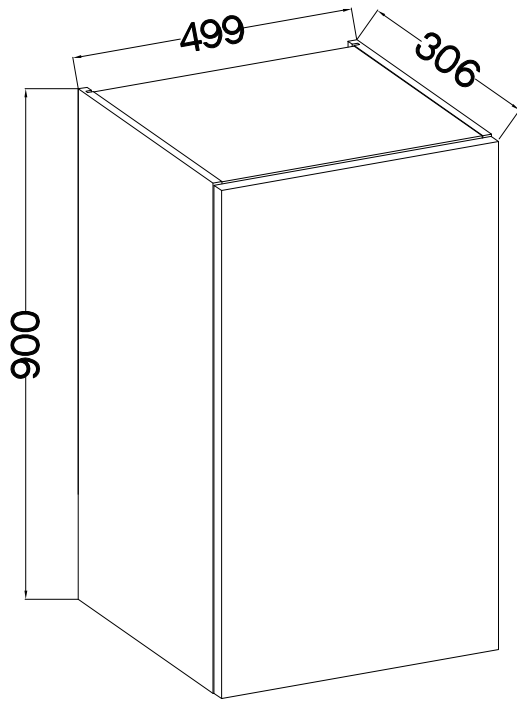
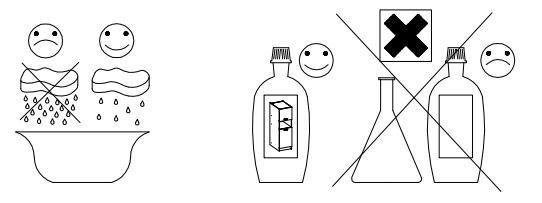

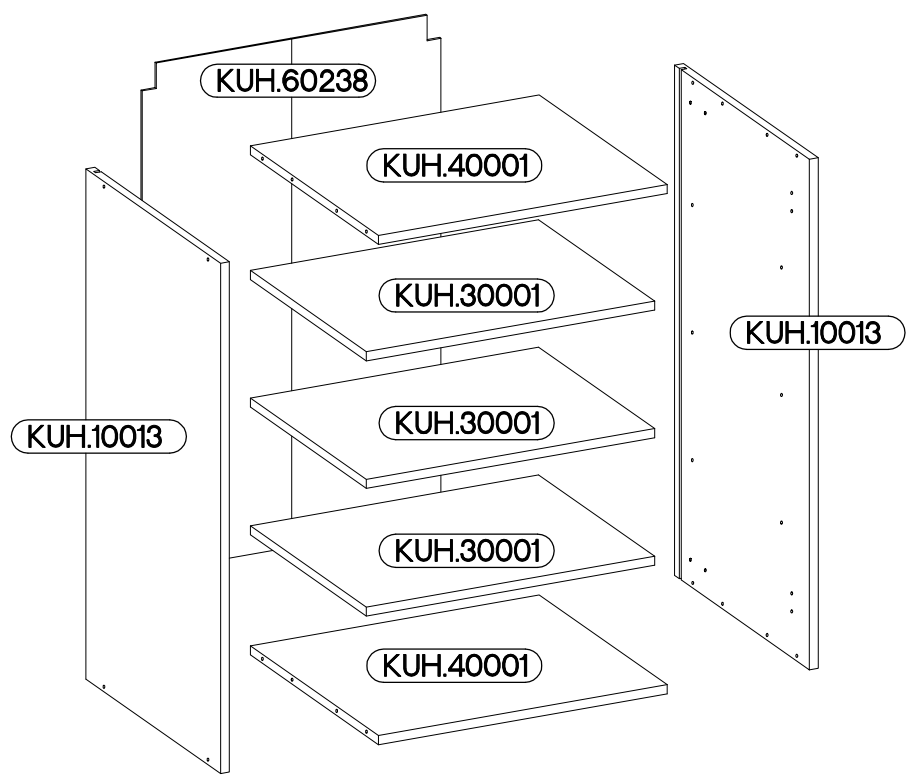
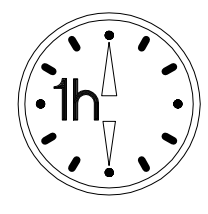

KUH.30001
KUH.40001

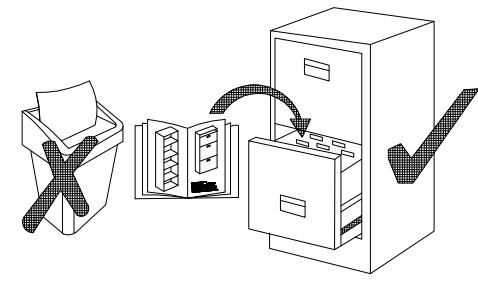

 8x30mm A 8	 6,4 x 50mm B 8	 E1 8	 35/0mm HG 2
 J 12	 K 2	 O 1	 3.5x13mm P5 4
			 3.0x20mm P7 8-10
			 4.0x30mm P8 4



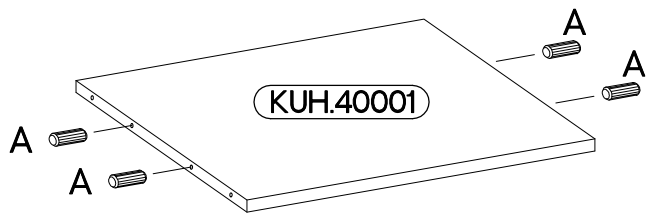
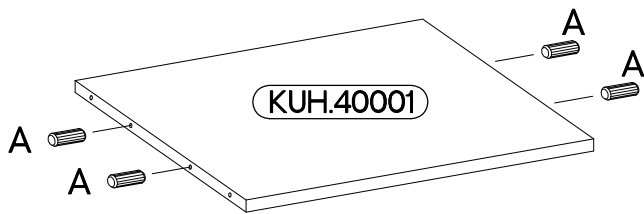
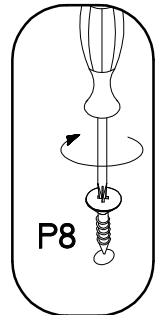
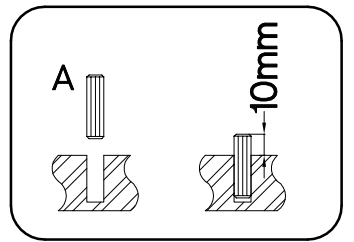
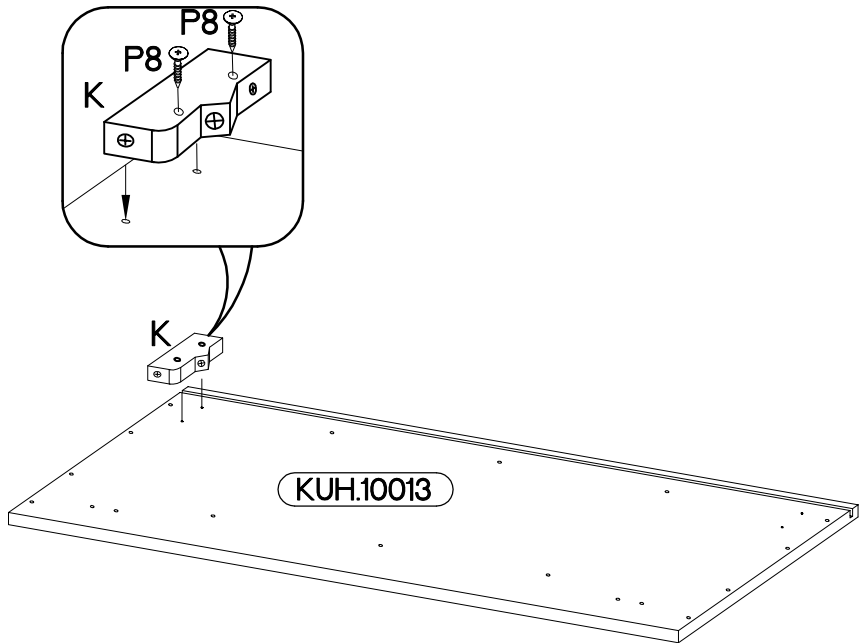
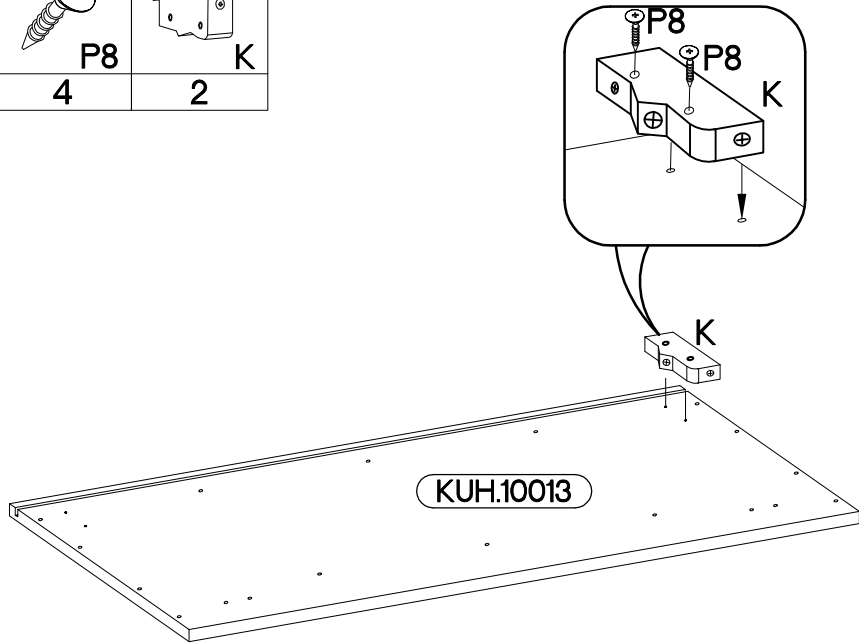
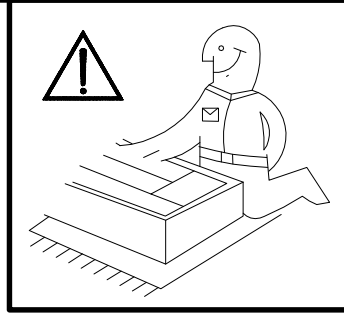

ISM-KUH-01125

 <p>±8x30mm A</p>	 <p>±4.0x30mm P8</p>	 <p>K</p>
8	4	2



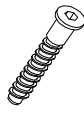
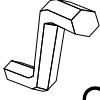

2

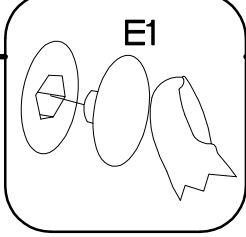
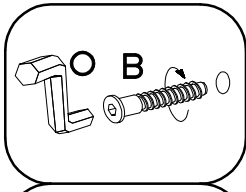
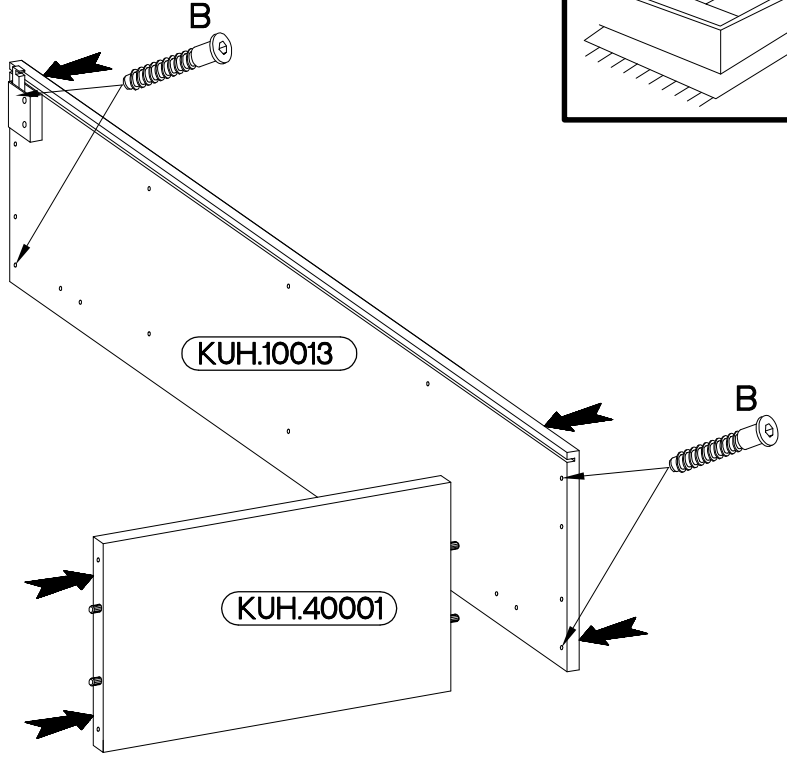
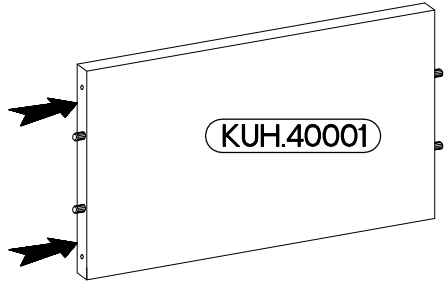
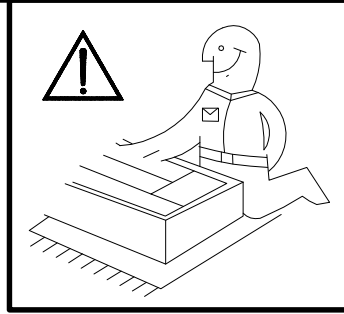
6,4 x 50mm		
		
B	O	E1
4	1	4

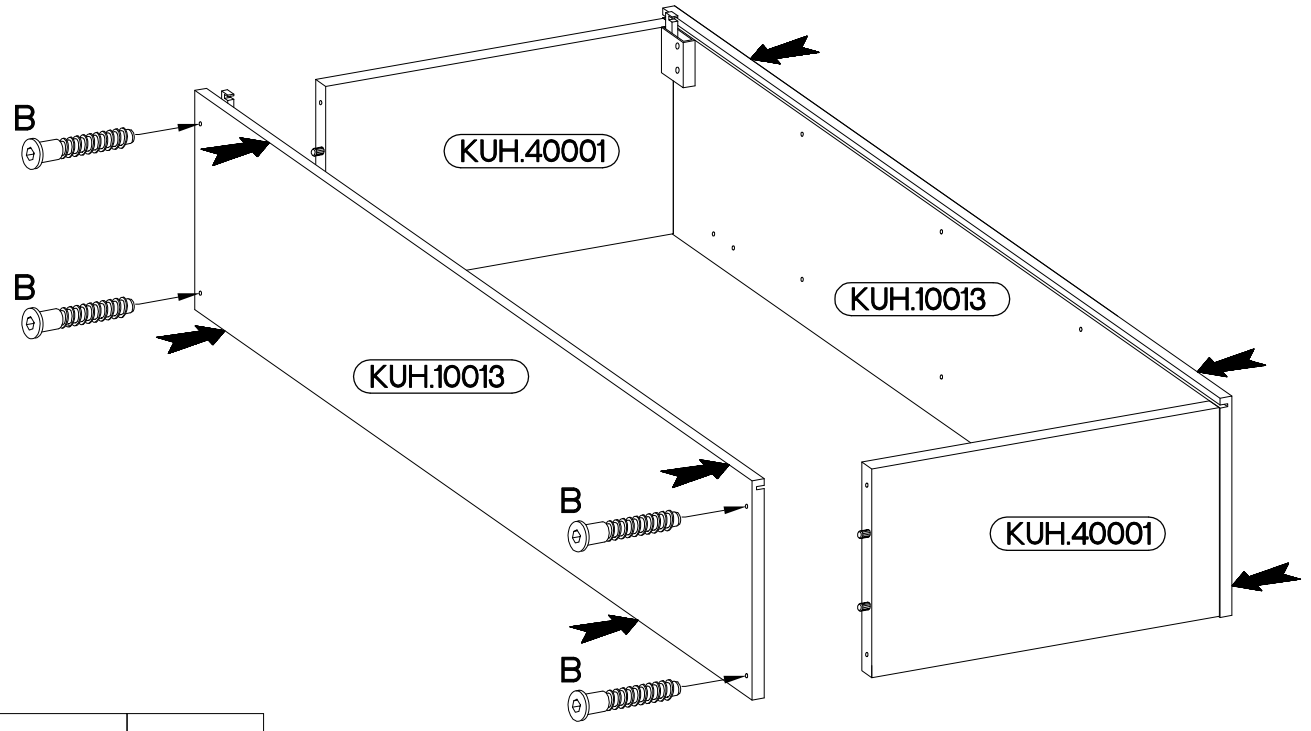

3

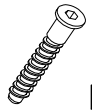
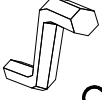

6,4 x 50mm		
		
B	O	E1
4	1	4

4

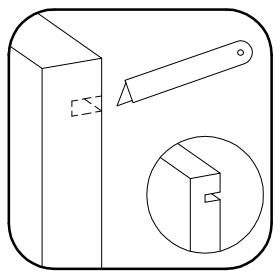
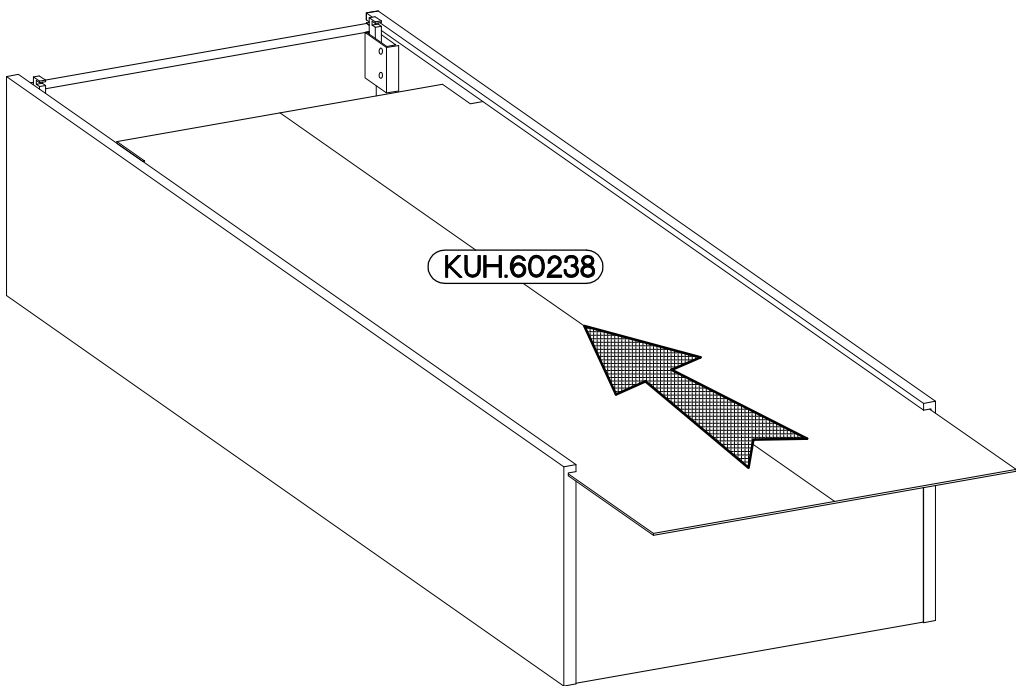
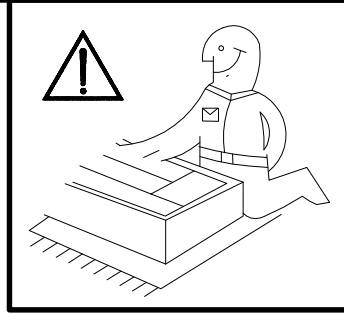

5

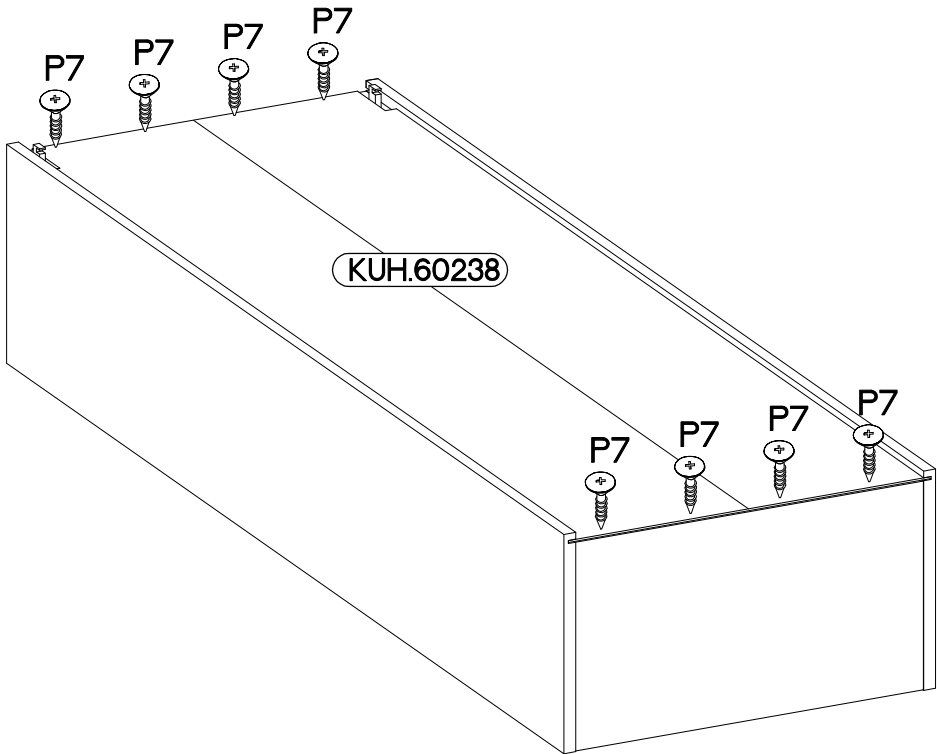
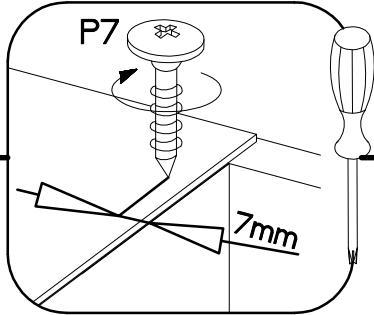
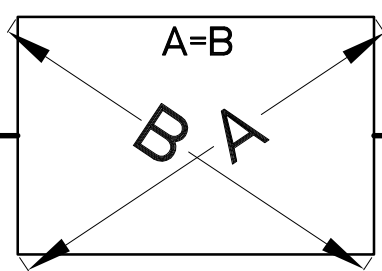
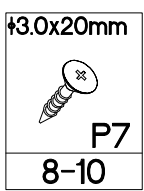

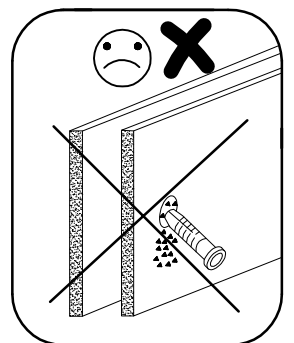
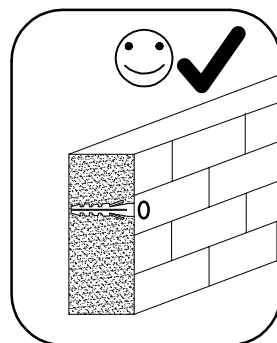
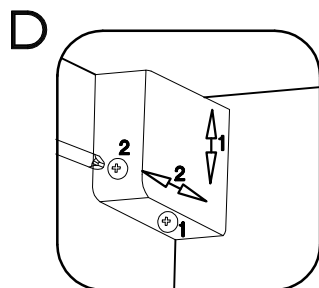
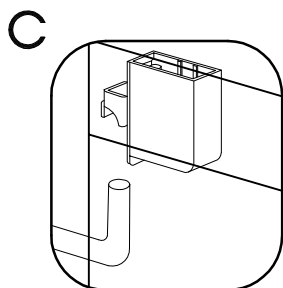
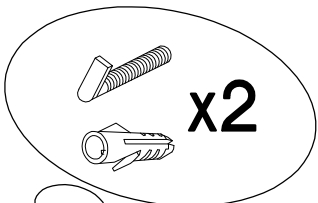
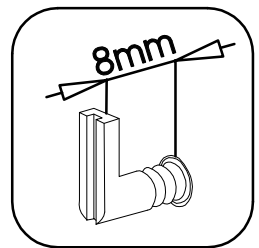
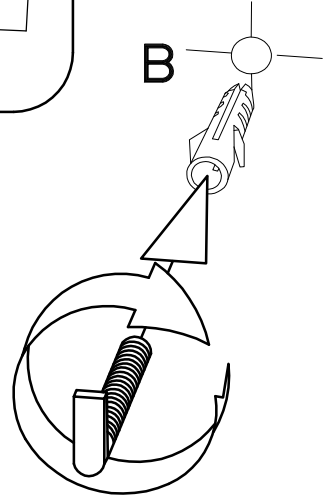
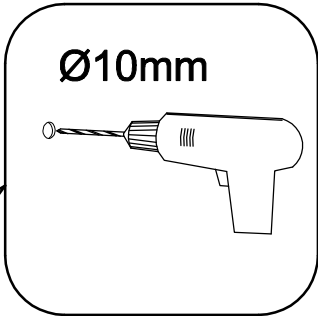
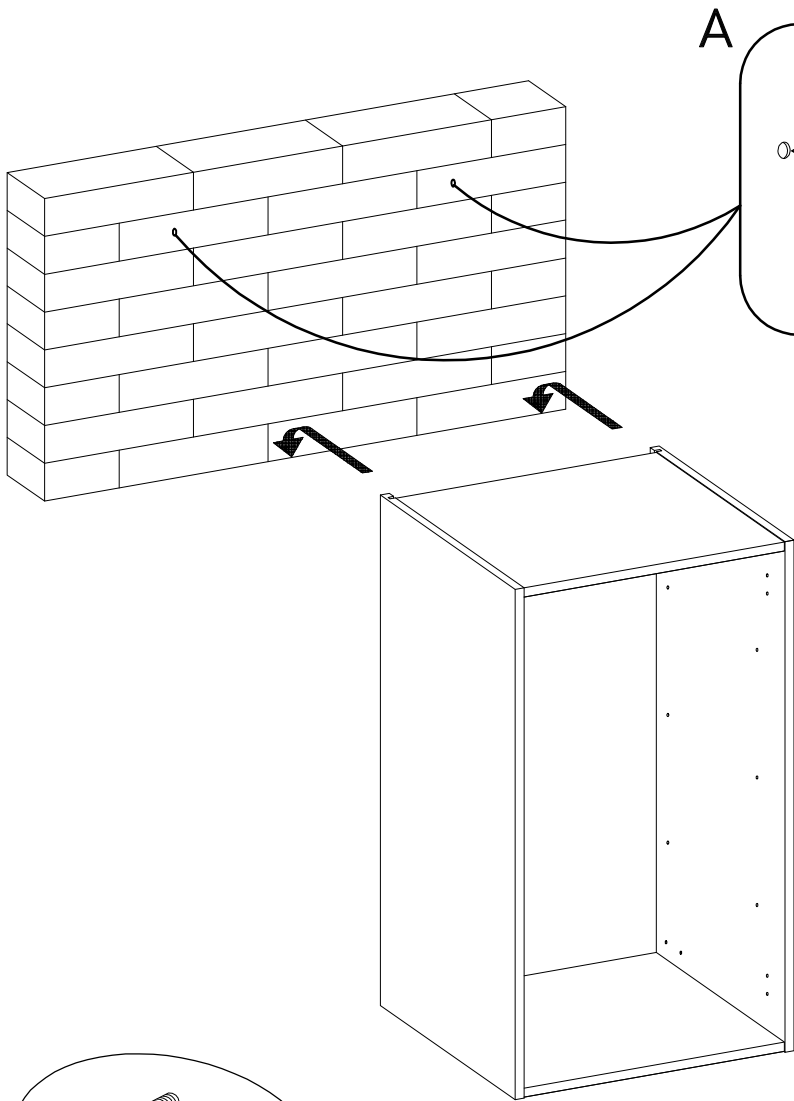
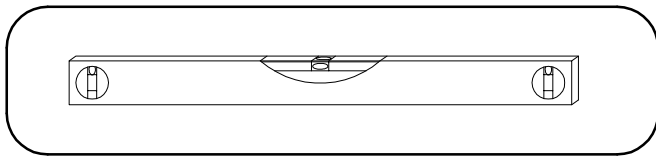

7

±5/19mm
J
12

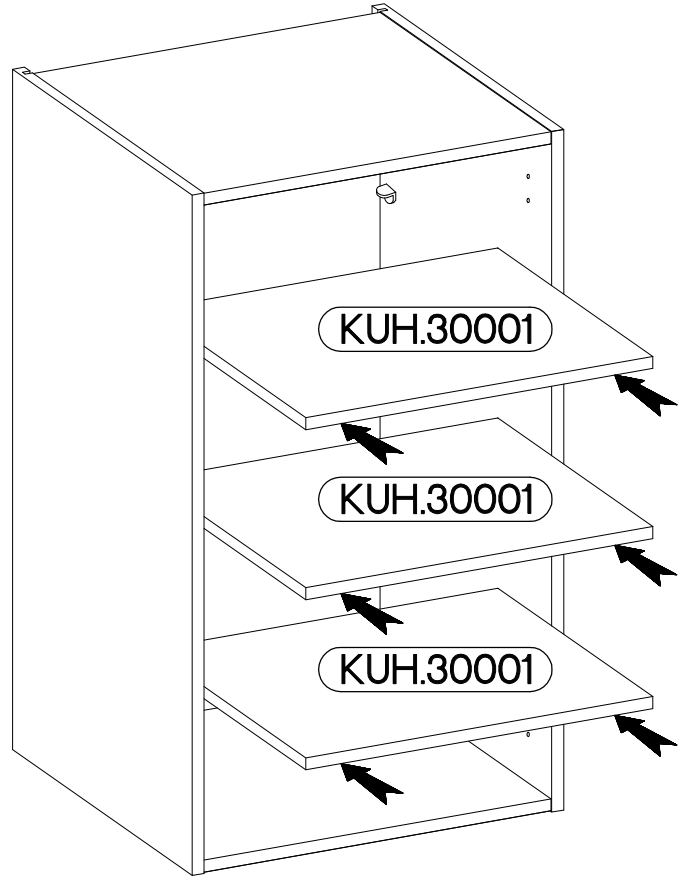
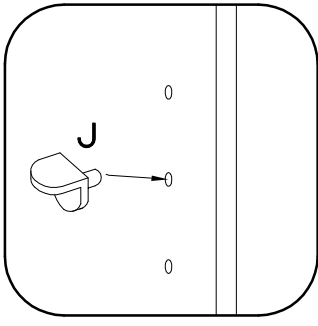

8

FRONT

