

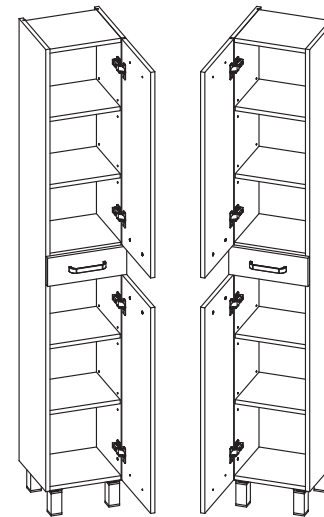





















30 2D-1S



A1  8x32 x 12	BS2  H=2 x 4	BSZ0  KR=0 x 4	K1  x 6	H1  x 3
F8  ~ 12	G  x 6	N7  US3,5x12 x 4	O13  x 4	N5  US3,5x16 x 16
D1  x 16	P0  ∅ 5 x 44	P3  ∅ 10 x 2	F1  x 12	E1  x 12
K10  M4x9 x 2	L  Glue x 1	PK25  x 2	Q9  x 1	I2  UP3x12 x 2
R4  x 8				

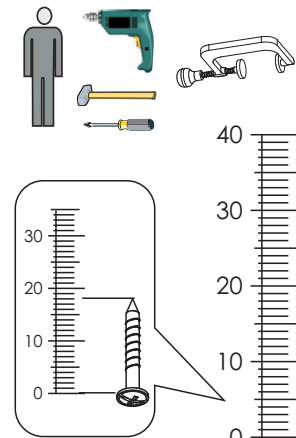

1

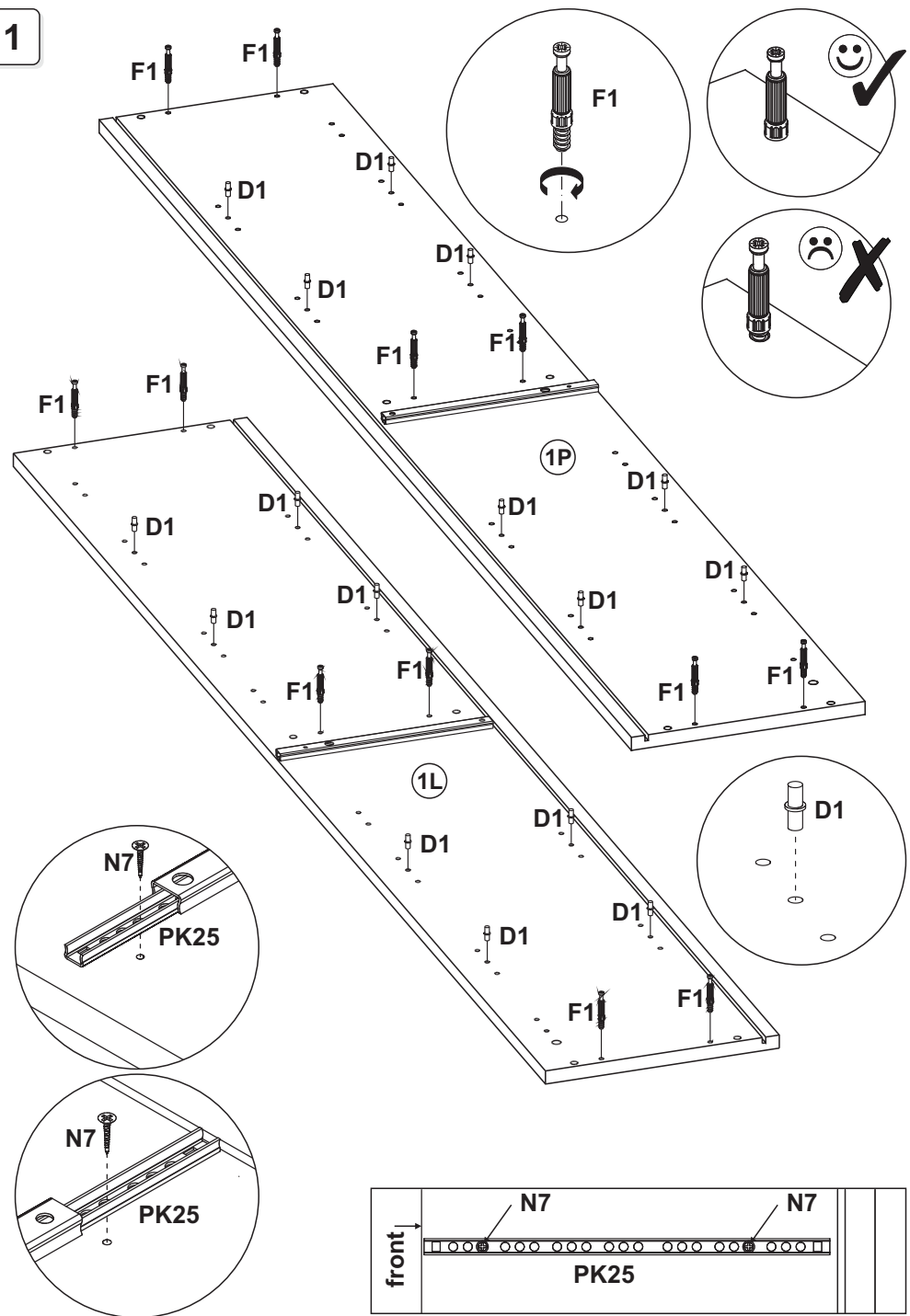

2

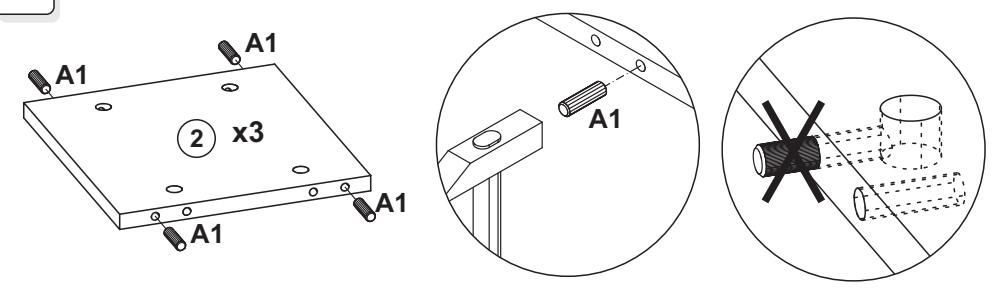

3

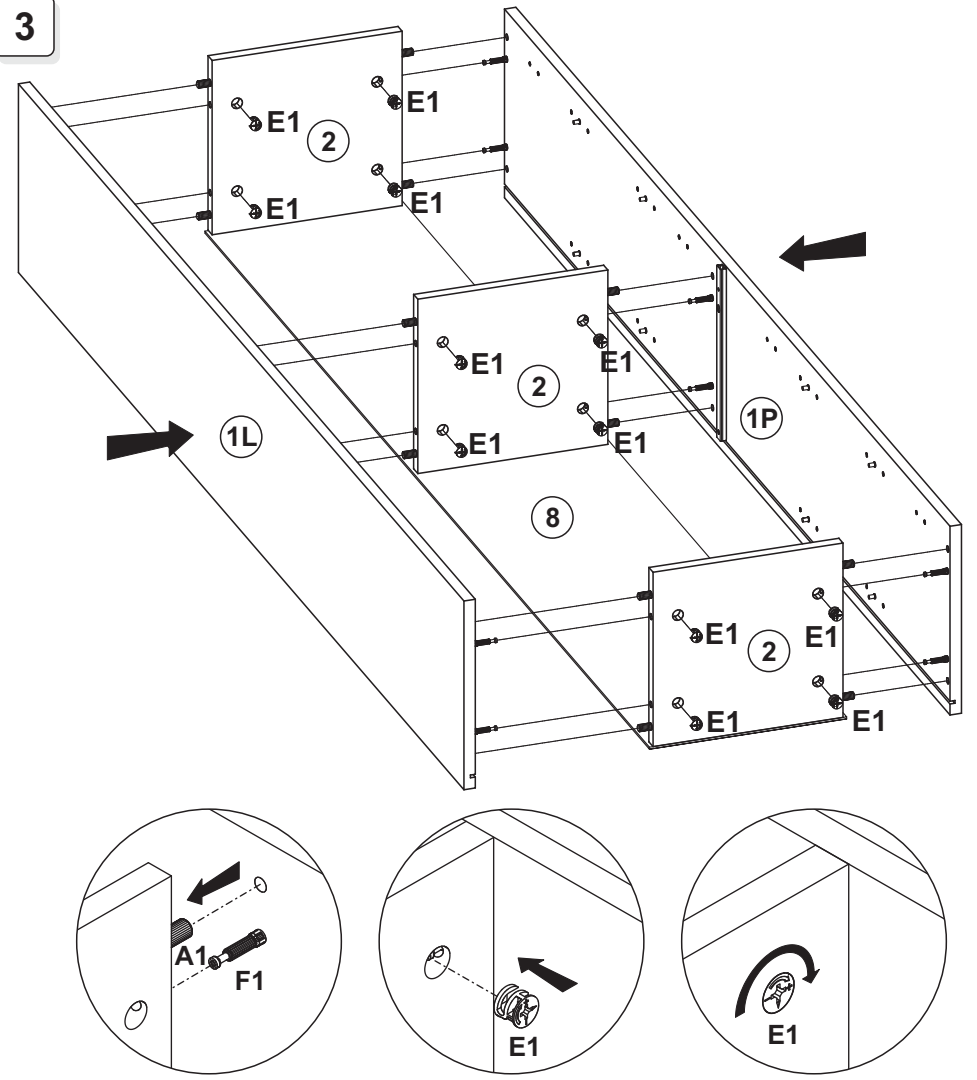

4

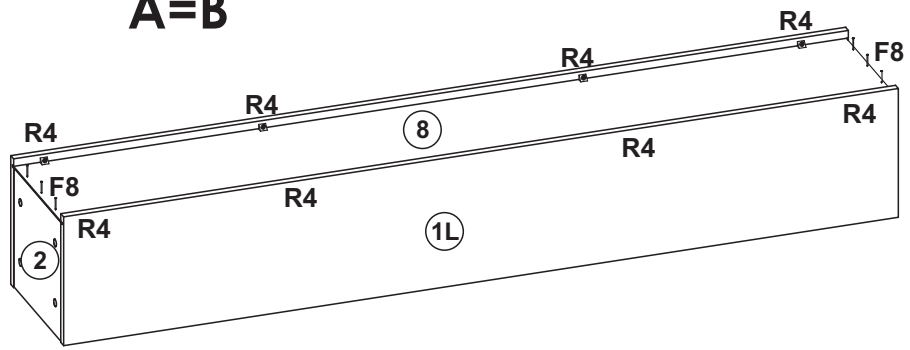
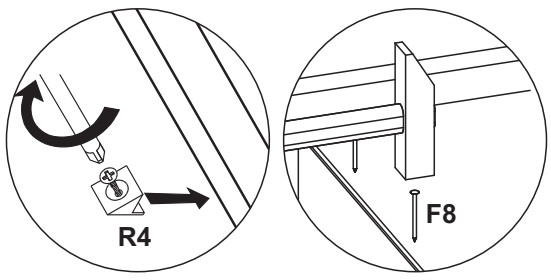
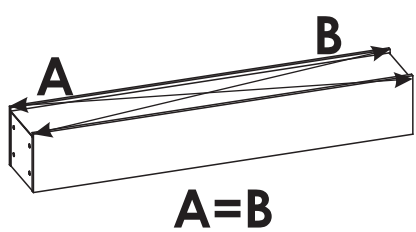

5

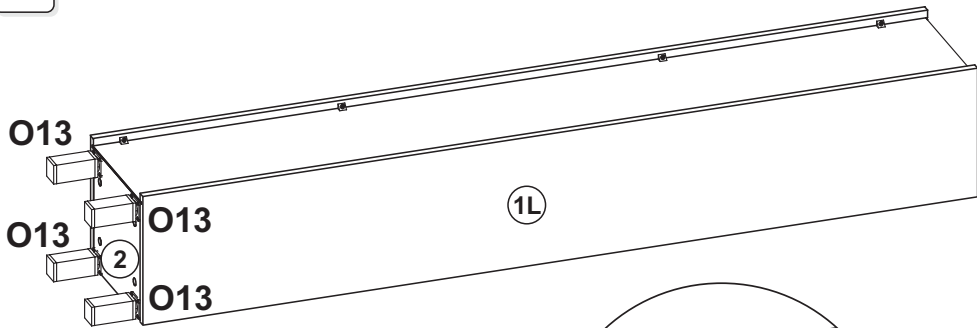

6

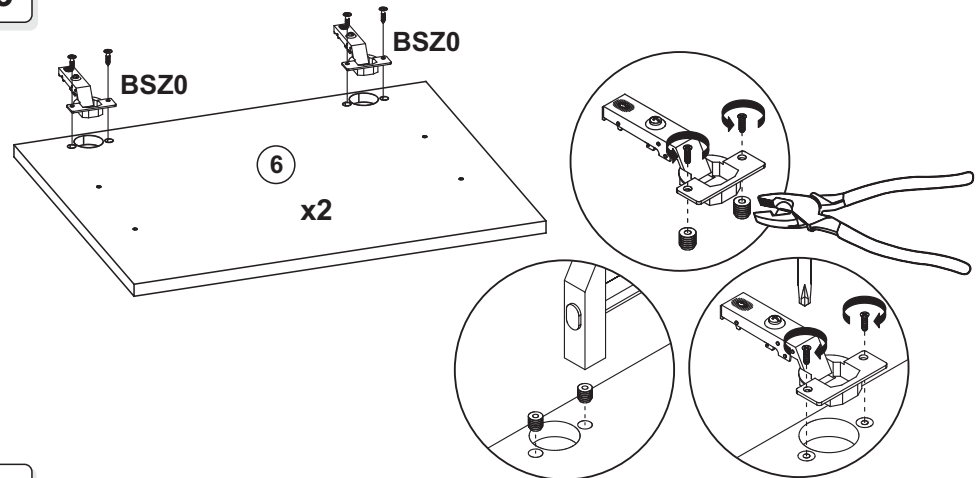

7

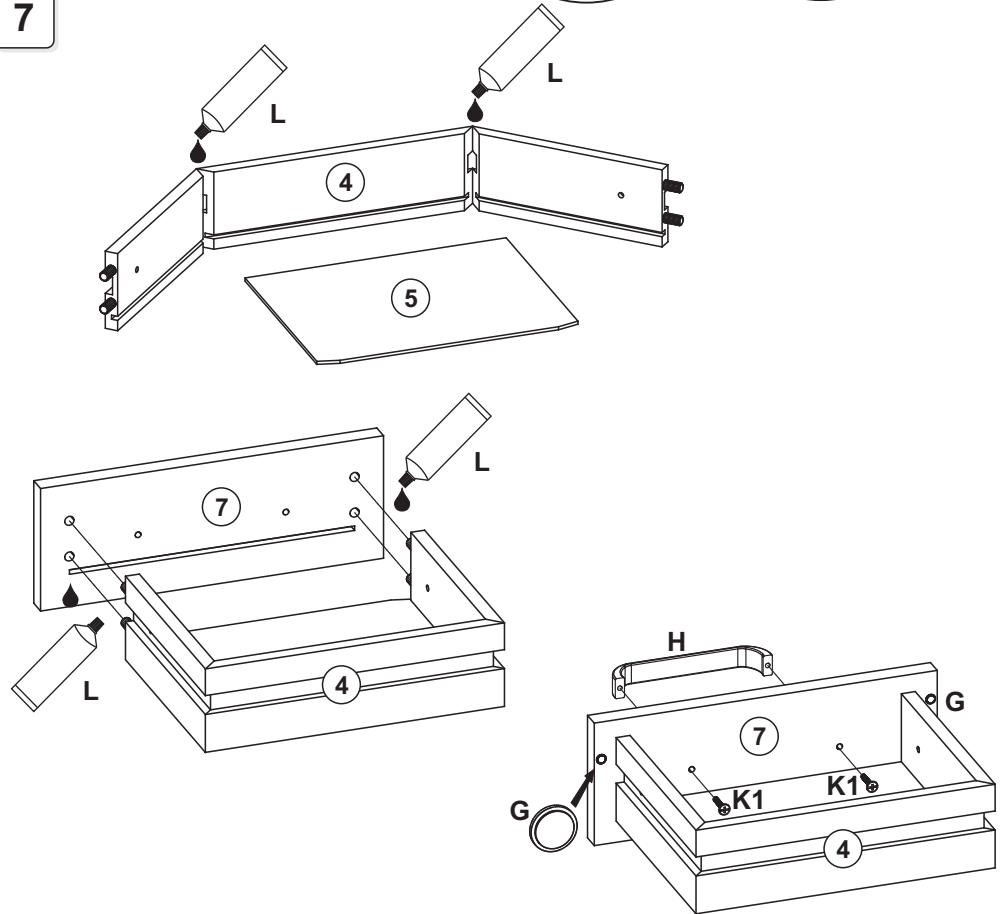

8

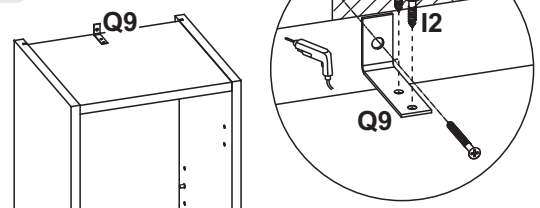

9

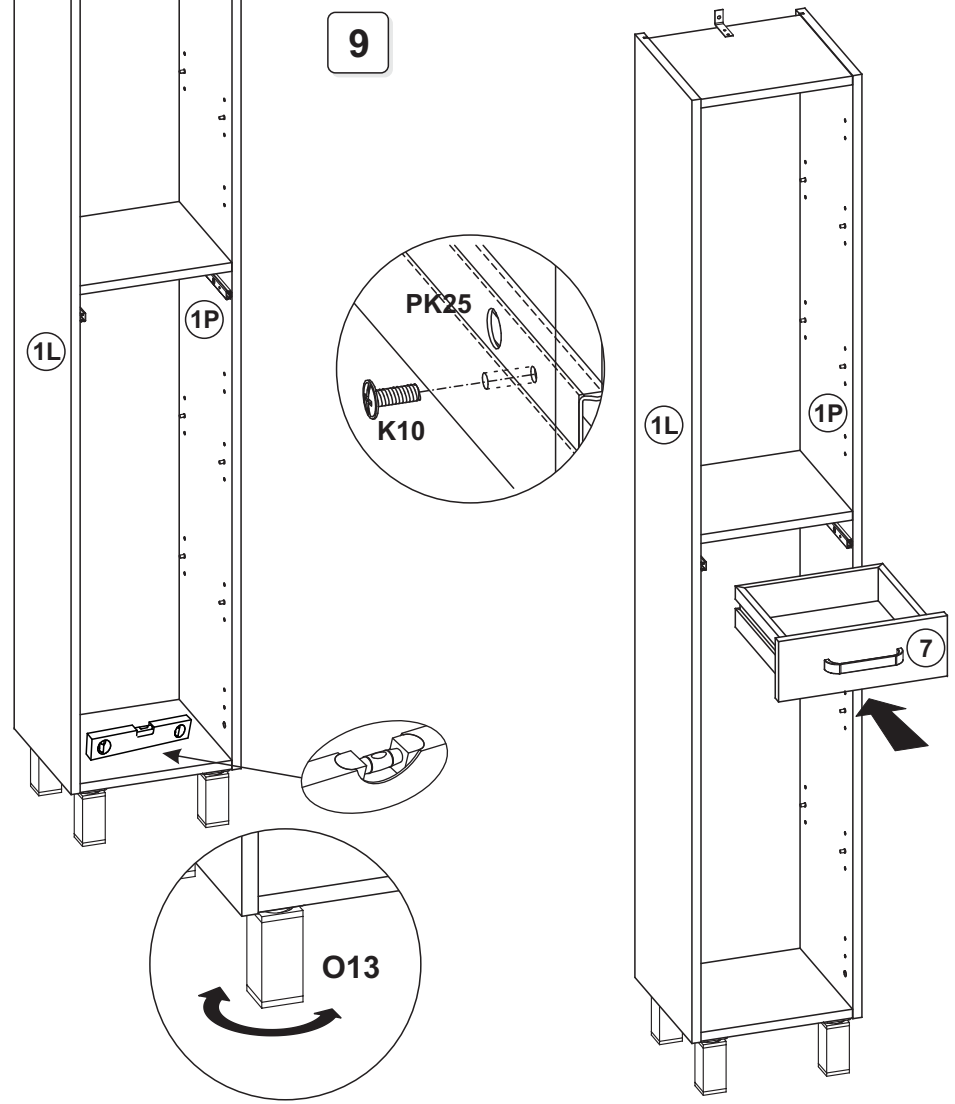

10

