

GB

D

CZ

SK

RUS

LT

assembly instructions / montageanleitung / montážní návod / montážny návod / инструкции по монтажу / surinkimo instrukcija





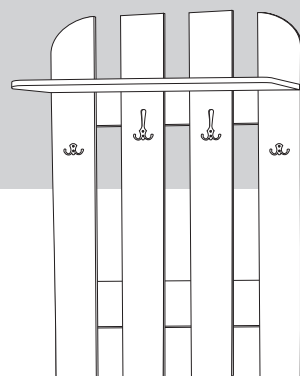

INSTRUKCJA MONTAŻU

W 80-01

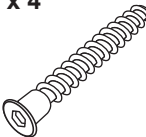
↑ 120 → 80 ↗ 24

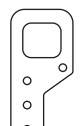
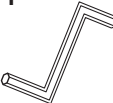
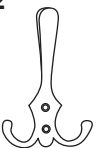

akcesoria / accessories / zubehör / příslušenství / príslušenstvo / аксессуары / furnitūra :

| | | | | | | | |
|--|--|---|--|--|--|--|--|
| <p>x 4</p>  <p>KT 7/60</p> | <p>x 8</p>  <p>WT 3x16</p> | <p>x 16</p>  <p>WT 4x30</p> | <p>x 8</p>  <p>WT 3,5x20</p> | <p>x 2</p>  <p>ZA P90x37</p> | <p>x 1</p>  <p>kluczyk / key / schlüssel / klíč / kľúč / ключ / raktas</p> | <p>x 2</p>  <p>WK 3N</p> | <p>x 2</p>  <p>WK 2N</p> |
|--|--|---|--|--|--|--|--|

do montażu potrzebne są:
 are needed for assembly:
 sind erforderlich für die montage:
 jsou potřebné pro montáž:
 sú potrebné pre montáž:
 которые необходимы для сборки:
 Surinkimui reikės

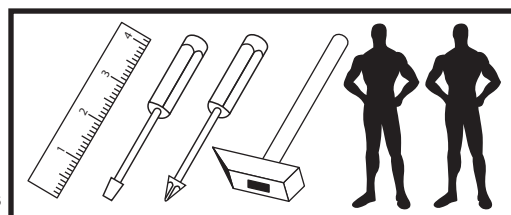

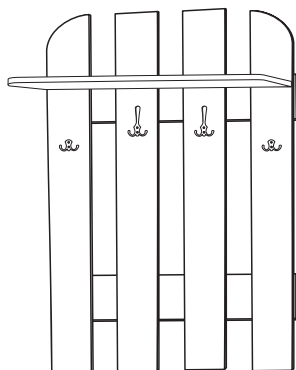

| | CODE | | | |
|----|----------|------|-----|---|
| 1 | W8001_01 | 1194 | 160 | 1 |
| 2 | W8001_02 | 796 | 185 | 1 |
| 3 | W8001_03 | 796 | 92 | 2 |
| 4 | W8001_04 | 1194 | 160 | 1 |
| 5 | W8001_05 | 1194 | 160 | 2 |
| 6 | | | | |
| 7 | | | | |
| 8 | | | | |
| 9 | | | | |
| 10 | | | | |

