

ELENA 4D 2S-L

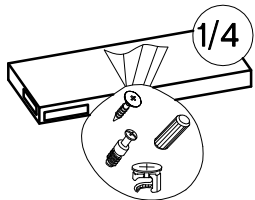

 +8x30mm A	 +6x42mm B2	 +15/12mm C	 +12/10mm C5	 L=20mm D2	 E					
68	6	32	4	36	28					
 6.5x48x16 F2	 +15x5mm F4	 +35/9mm H=0 HG1	 +35/16mm HG2	 L=450mm I15	 L=418mm J2	 +5/16mm J3	 J17	 L=450 mm K34	 L2	
4	4	6	6	2	2	8	4	2	24	
 L19	 +6,3x13mm M2	 +6,3x9,5mm M4	 +10x50mm O7	 +4.0x16mm P1	 +3.5x13mm P5	 +3.0x20mm P7	 +5.0x60mm P12	 +4.0x30mm R2	 L=128mm S	 T3
2	12	12	2	12	44	95-100	2	8	4	6

P-ISM-ELA-07

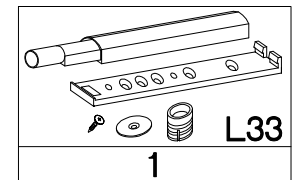
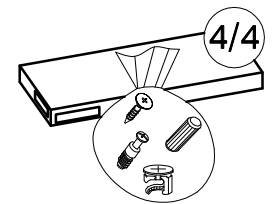
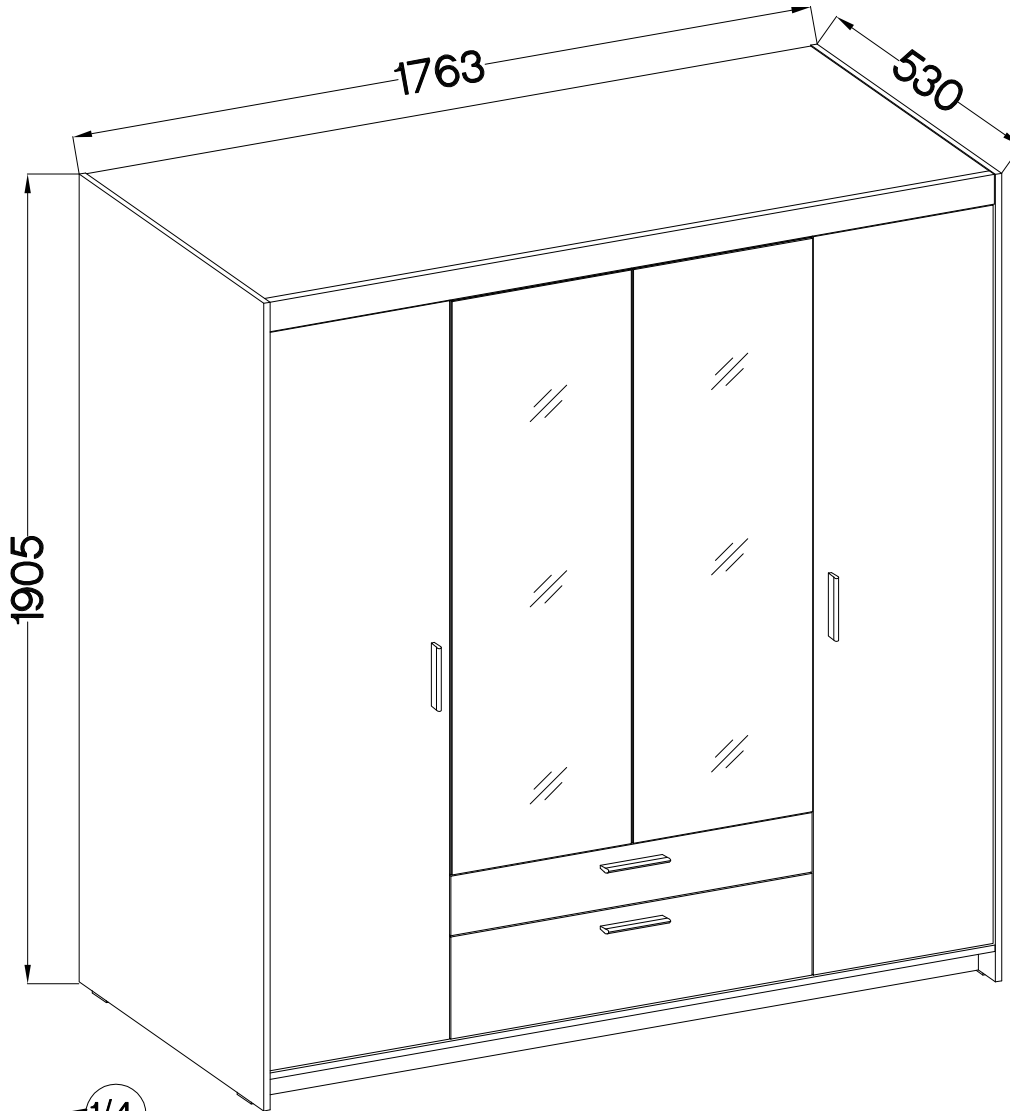
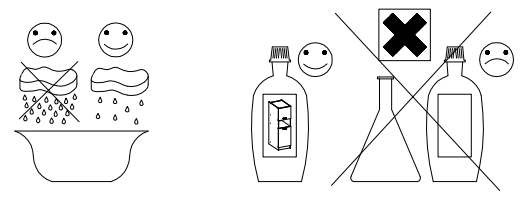
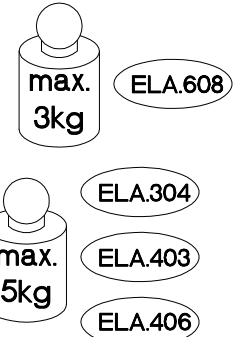
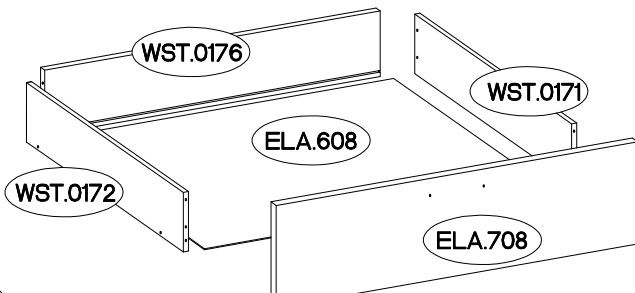
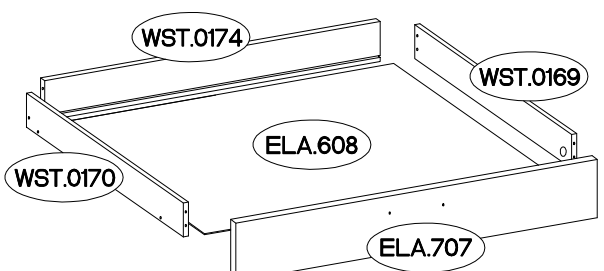
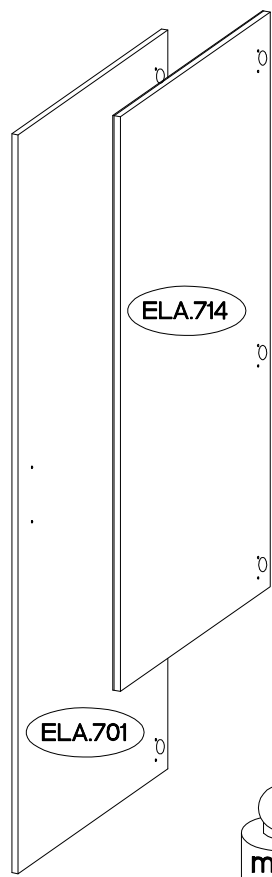
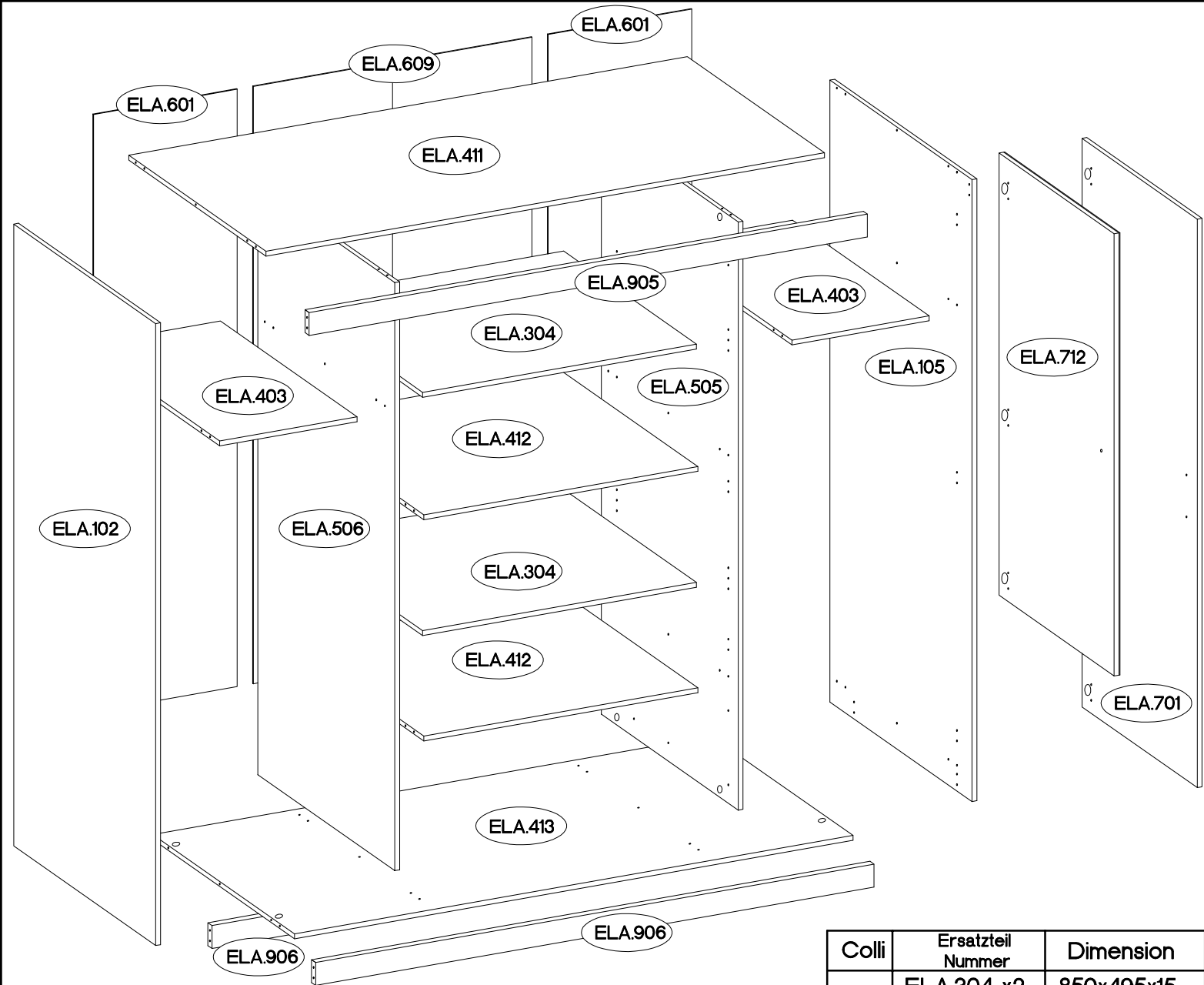



Colli	Ersatzteil Nummer	Dimension
Colli 4/4	ELA.701 x2	1737x430x15
	ELA.707	863x137x15
	ELA.708	863x240x15
	ELA.714	1351x430x19

Colli	Ersatzteil Nummer	Dimension
Colli 1/4	ELA.304 x2	850x495x15
	ELA.403 x2	426x510x15
	ELA.411	1733x512x15
	ELA.412 x2	851x510x15
	ELA.413	1733x529x15

Colli	Ersatzteil Nummer	Dimension
Colli 2/4	ELA.506	1797x511x15
	ELA.601 x2	1825x446x2.5
	ELA.608 x2	824x448x2.5
	ELA.609	1825x865x2.5
	ELA.905	1733x70x15
	ELA.906 x2	1733x70x15
	WST.0169	450x70x12
	WST.0170	450x70x12
	WST.0171	450x140x12
	WST.0172	450x140x12
WST.0174	801x84x12	
WST.0176	801x154x12	

Colli	Ersatzteil Nummer	Dimension
Colli 3/4	ELA.102	1900x530x15
	ELA.105	1900x530x15
	ELA.505	1797x511x15

L=20mm  D2 4	±12/10mm  C5 4	±8x30mm  A 8
---	--	---

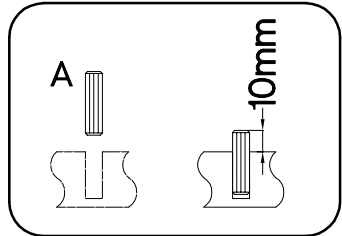
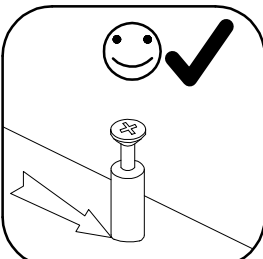
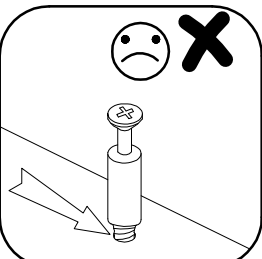
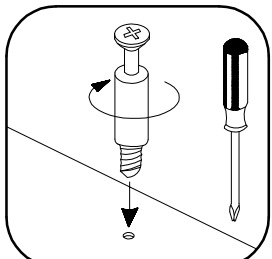
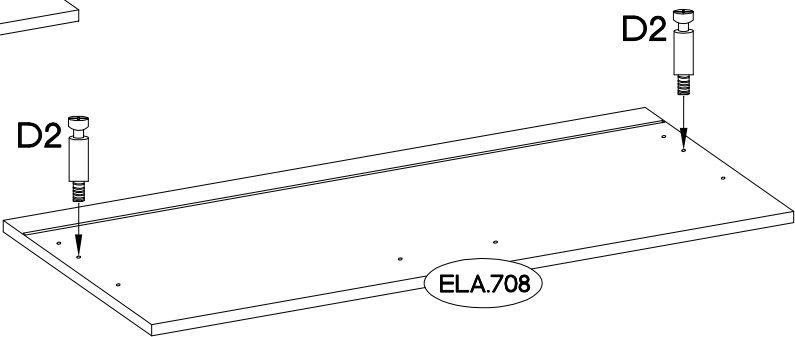
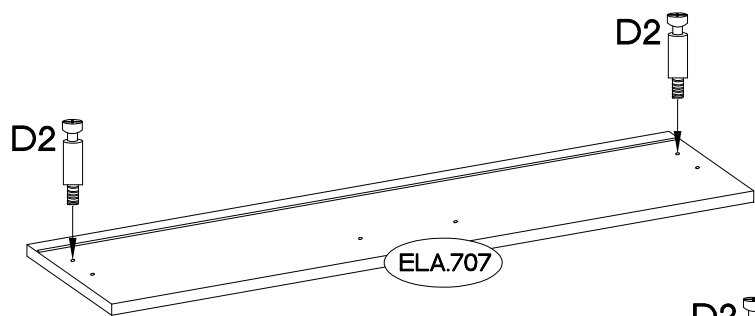
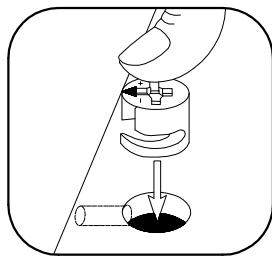
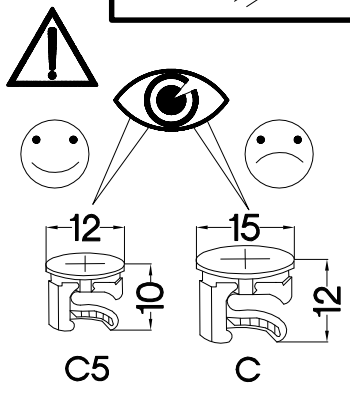
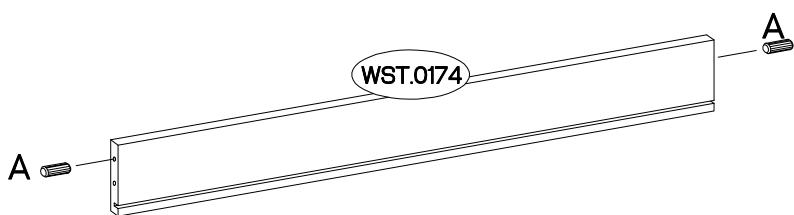
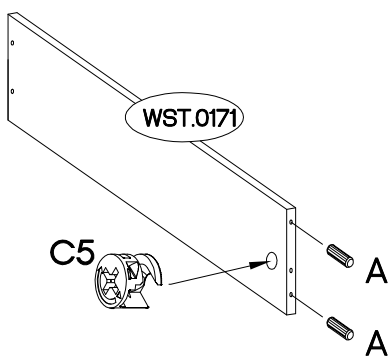
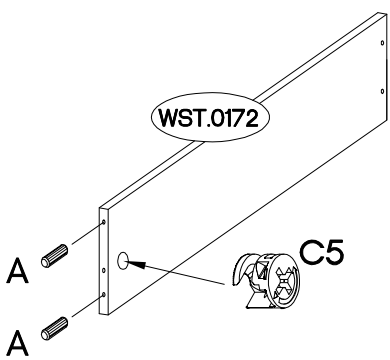
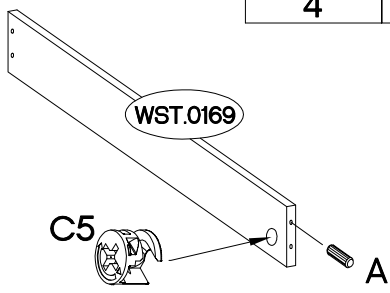
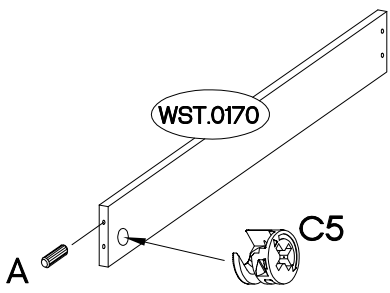
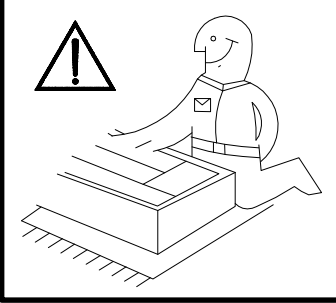

2

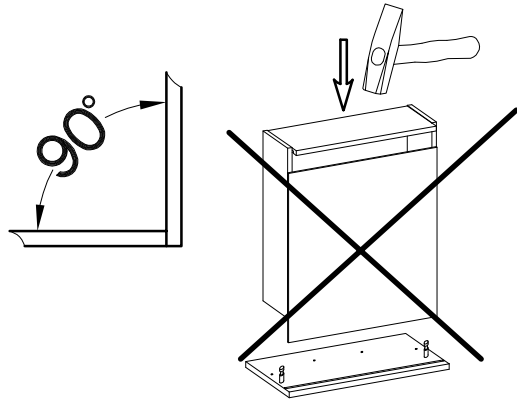
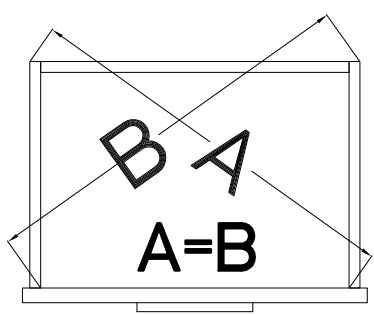
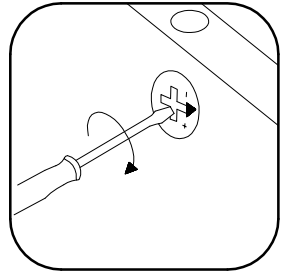
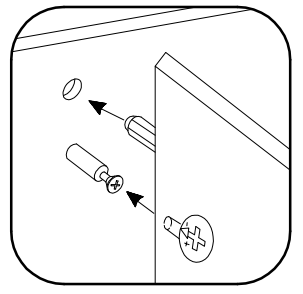
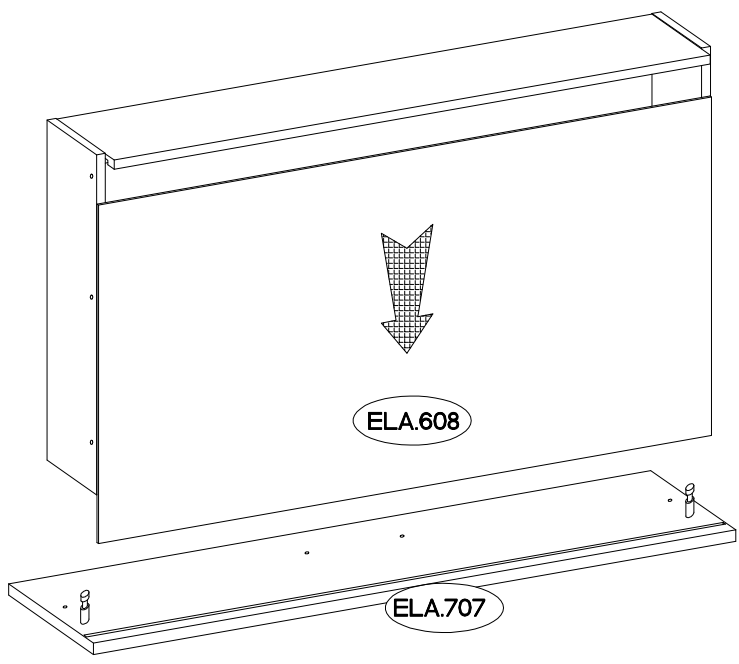
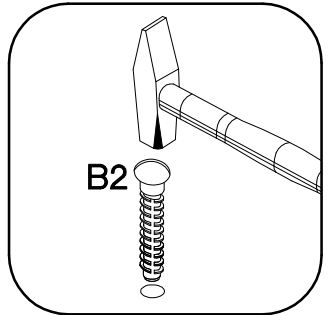
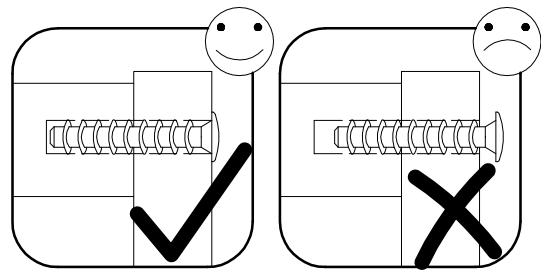
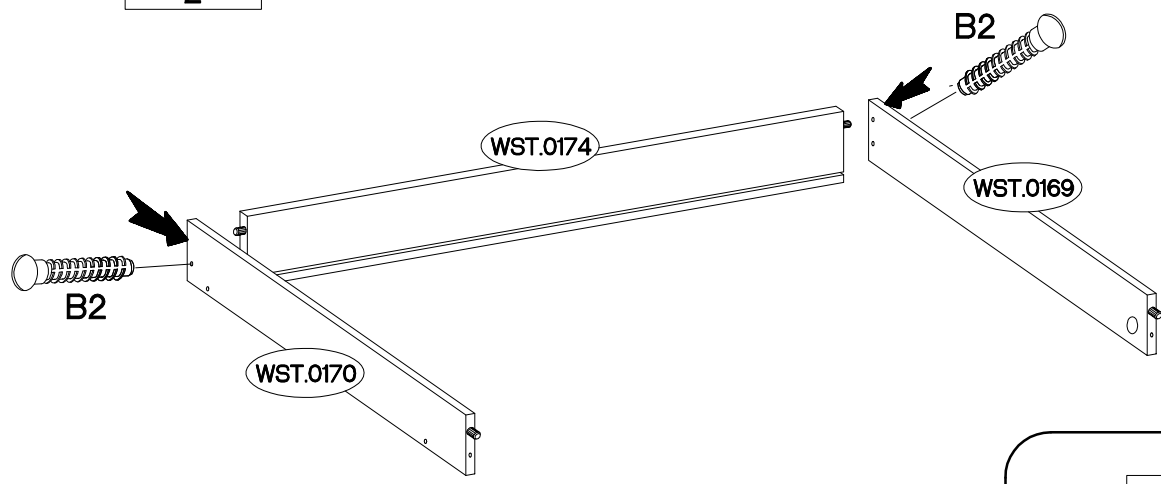
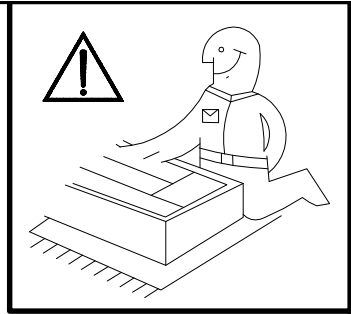

†6x42mm  
  
 B2  
 2

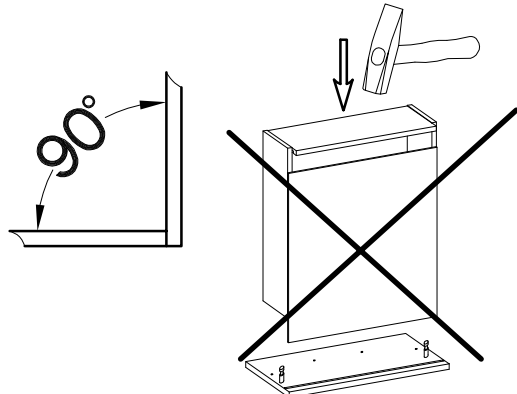
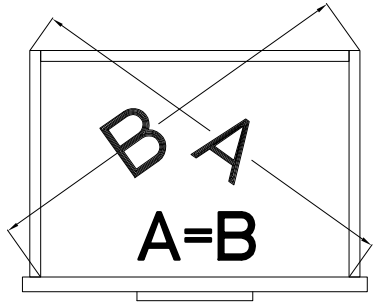
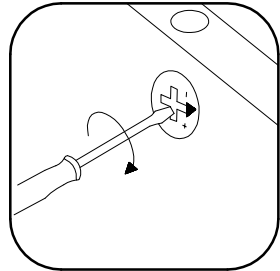
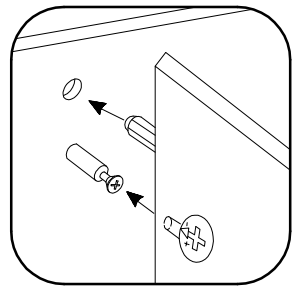
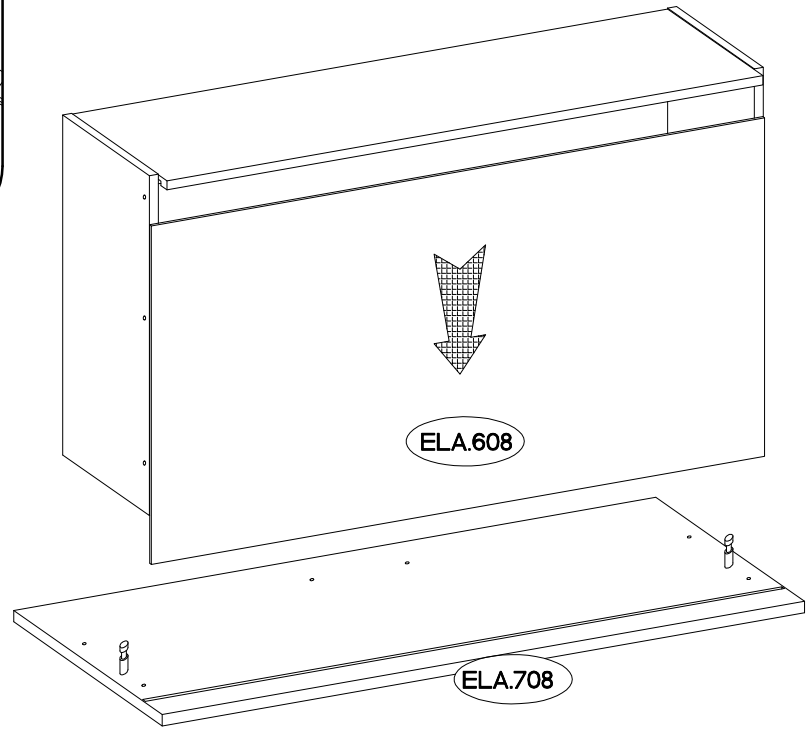
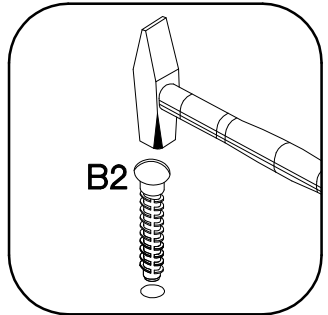
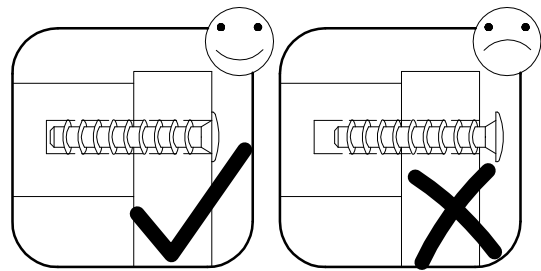
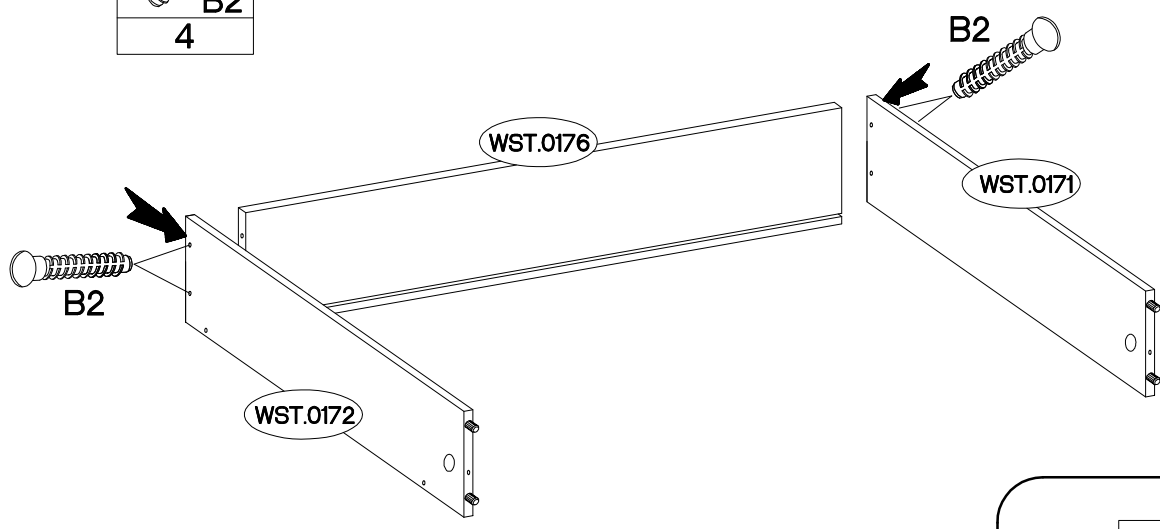
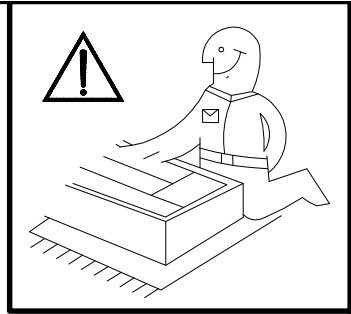
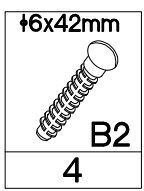

3



4

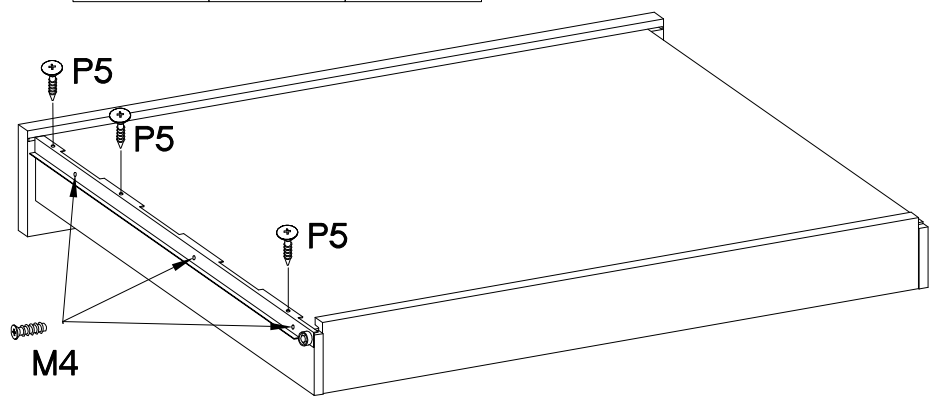
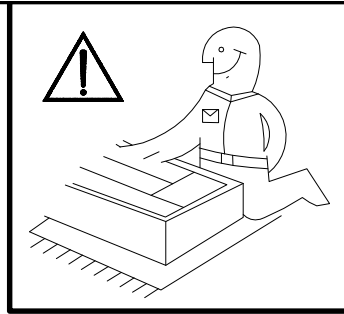
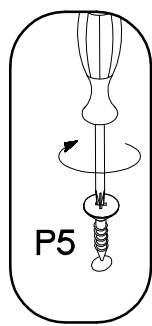

L=450mm  2	+6,3x9,5mm  12 M4	+3.5x13mm  6 P5
--	--	--

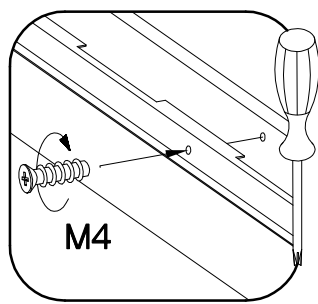
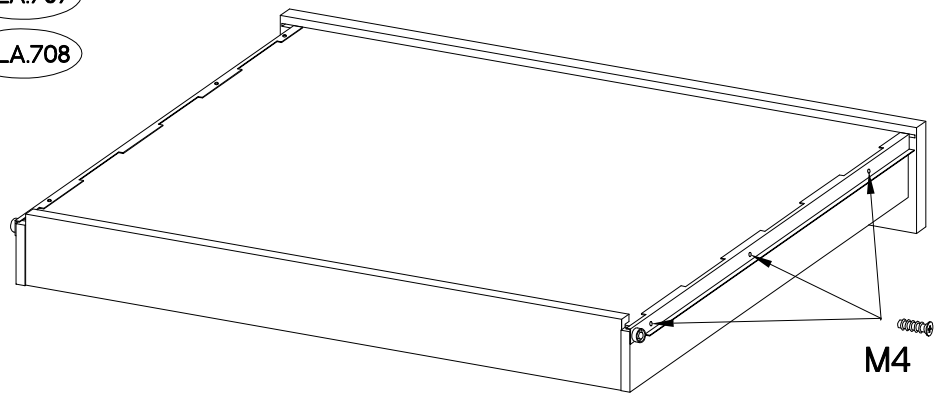

ELA.707  
ELA.708

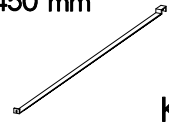

5

L=450 mm  2 K34	+3.5x13mm  4 P5
---	---

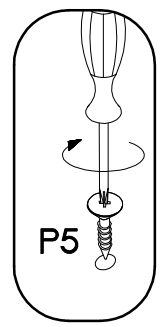
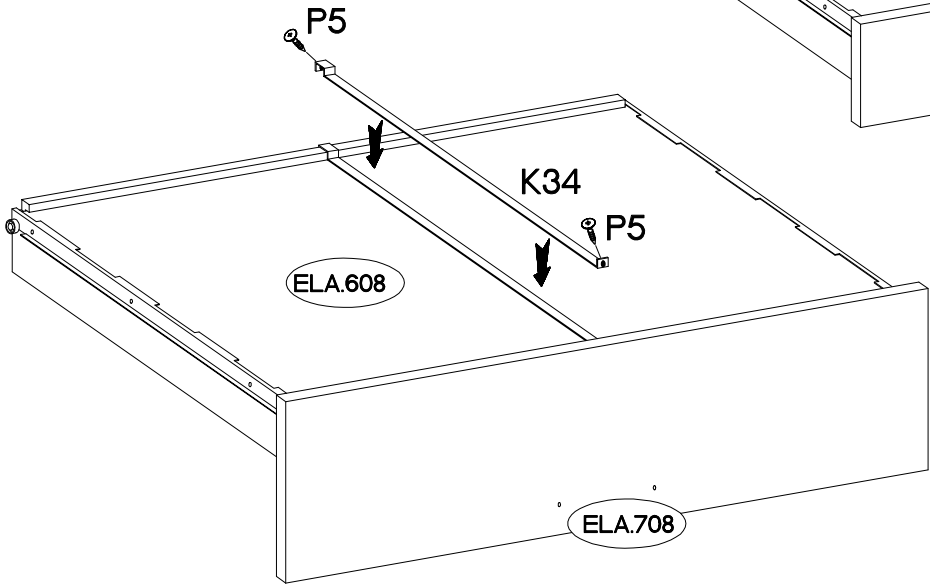
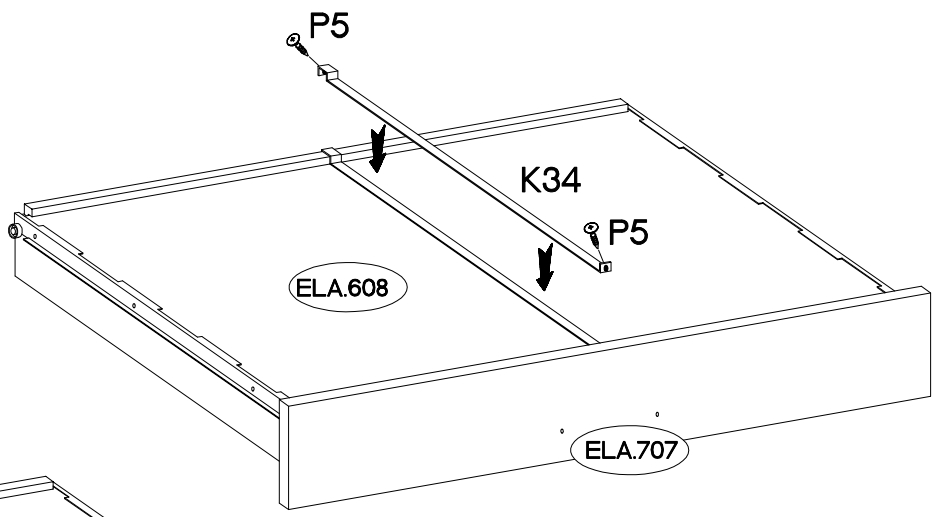

L=20mm  D2 12	6.5x48x16  F2 4	±8x30mm  A 24	±15/12mm  C 16	 L33 1	±3.5x13mm  P5 2
------------------------	--------------------------	------------------------	-------------------------	--------------	--------------------------

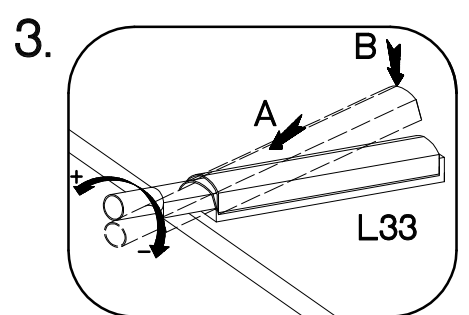
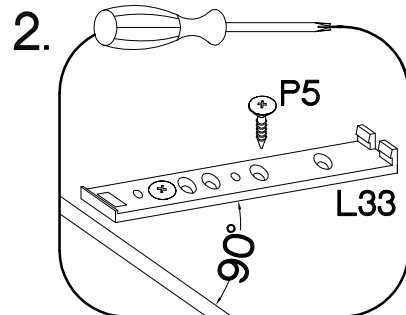
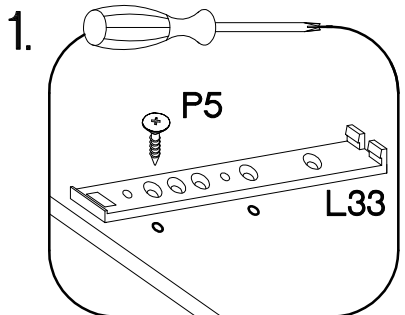
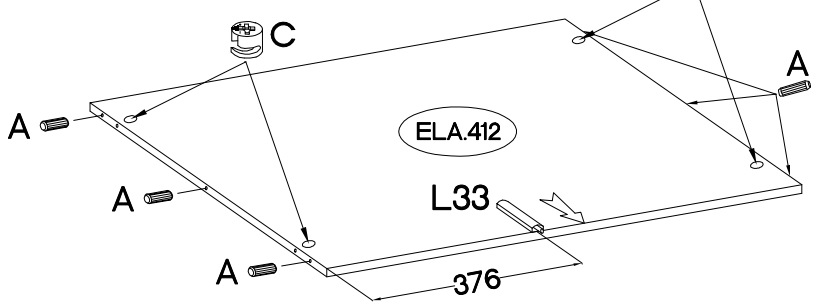
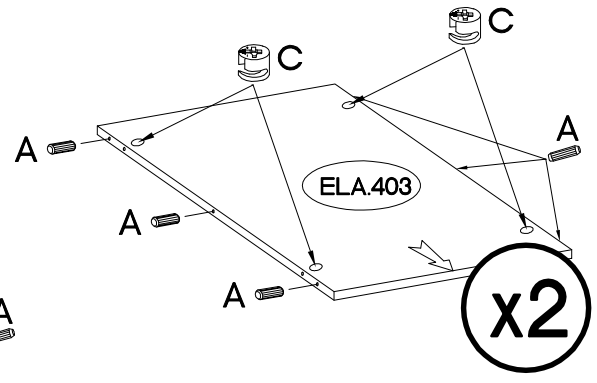
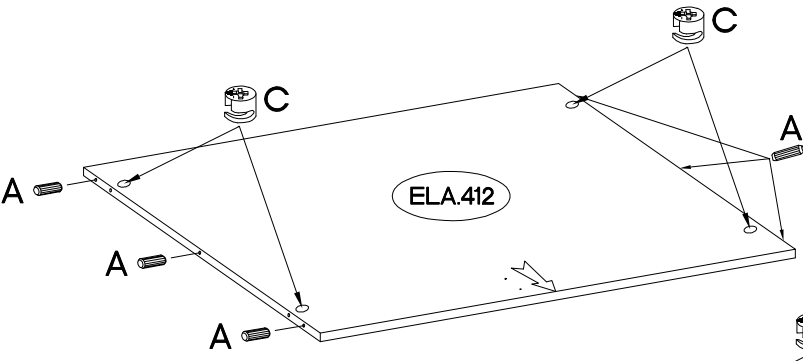
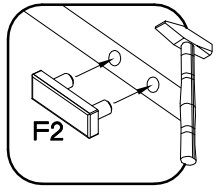
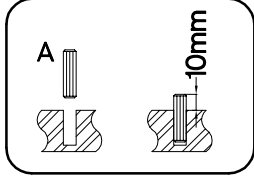
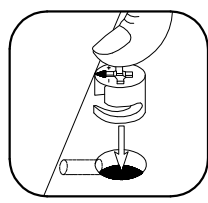
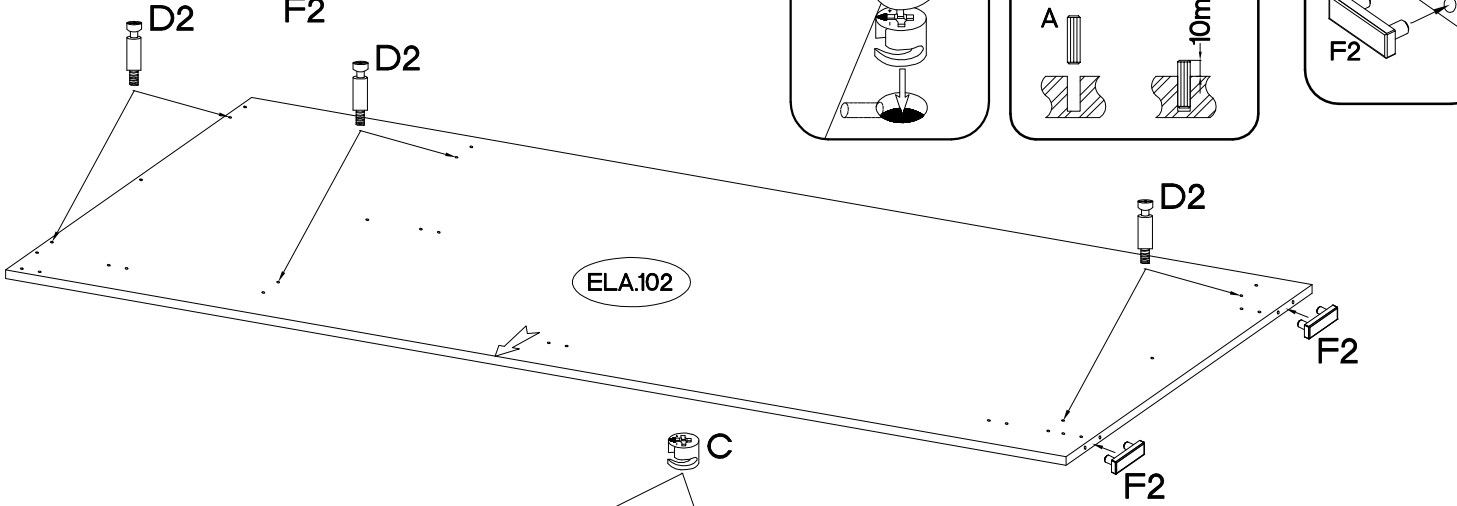
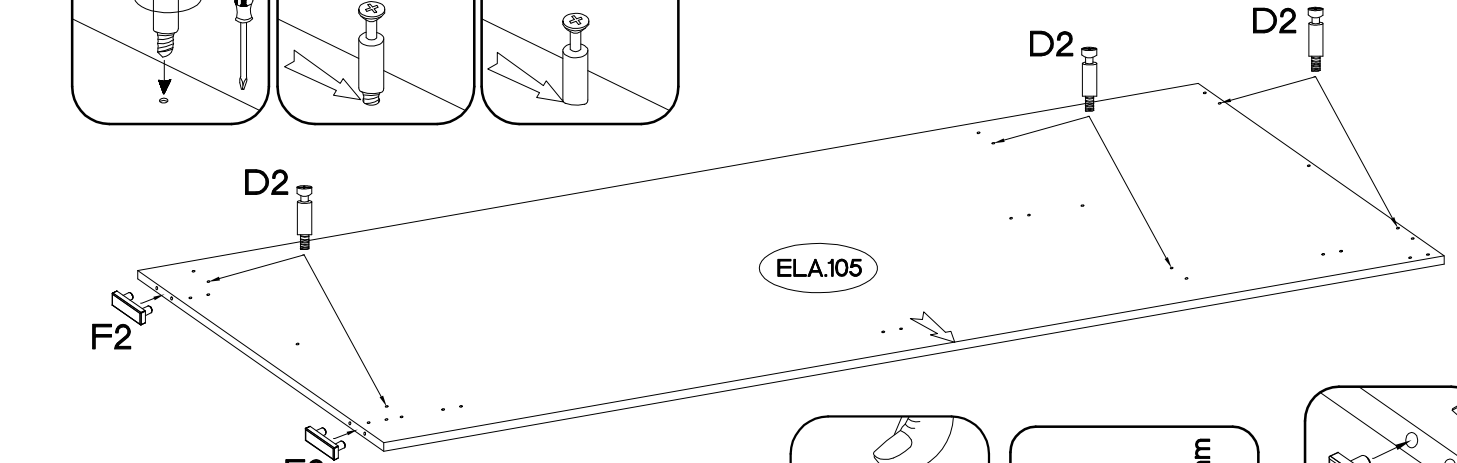
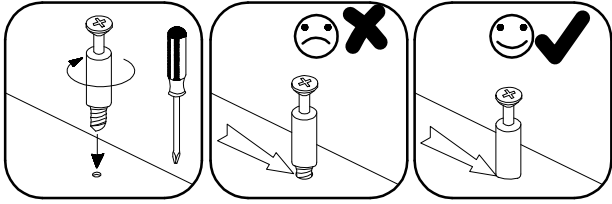
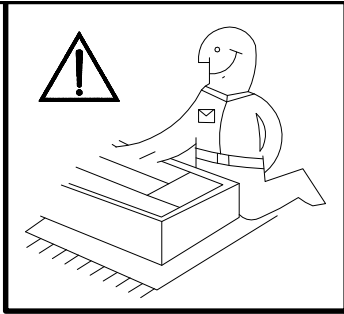

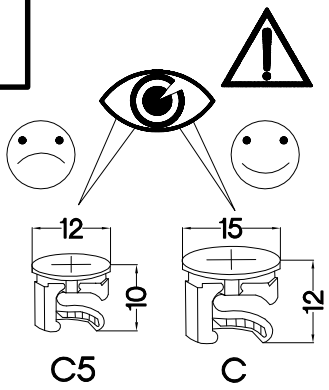



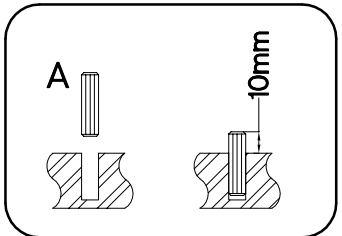
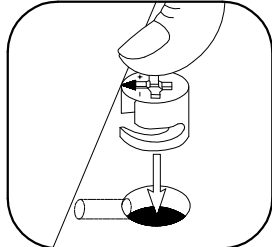
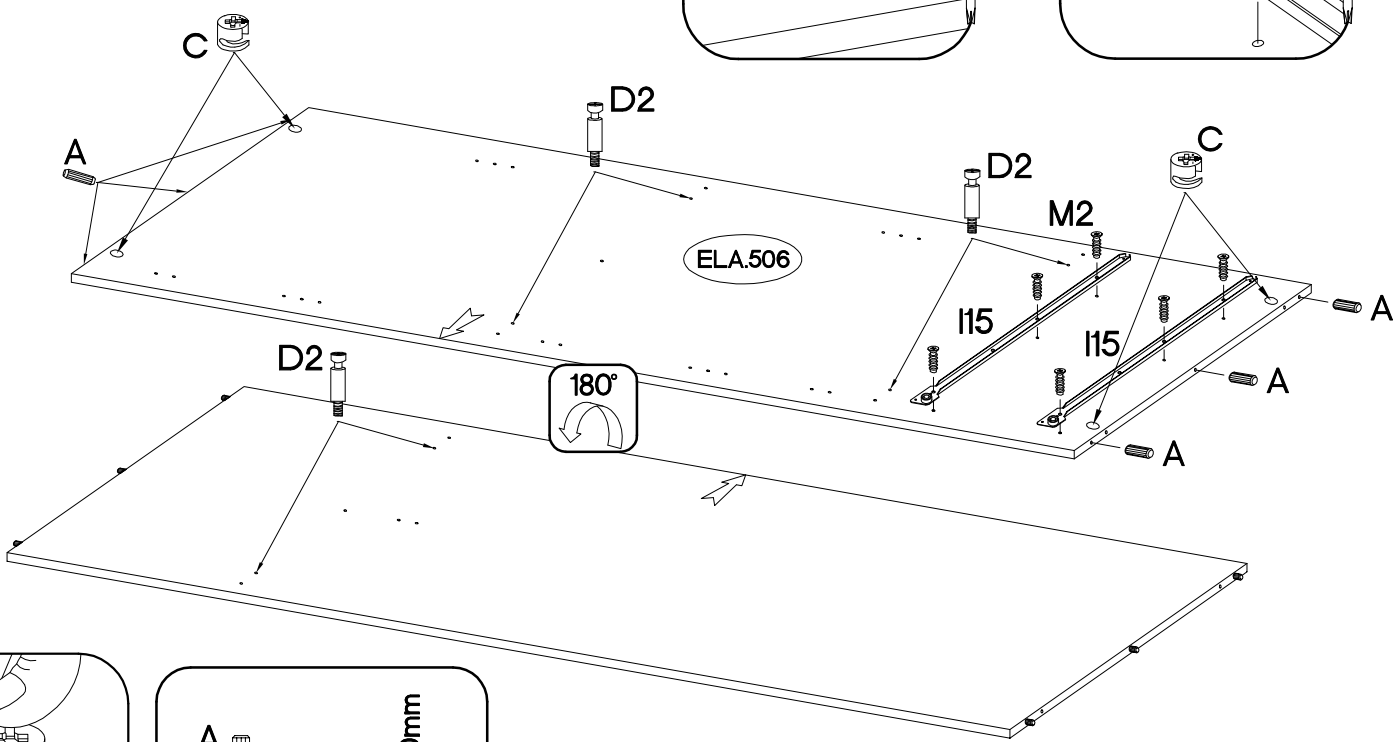
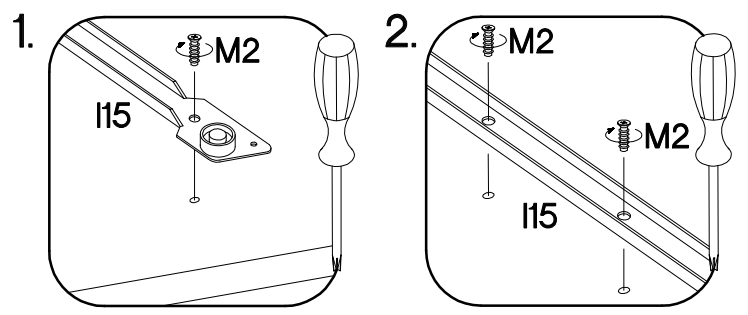
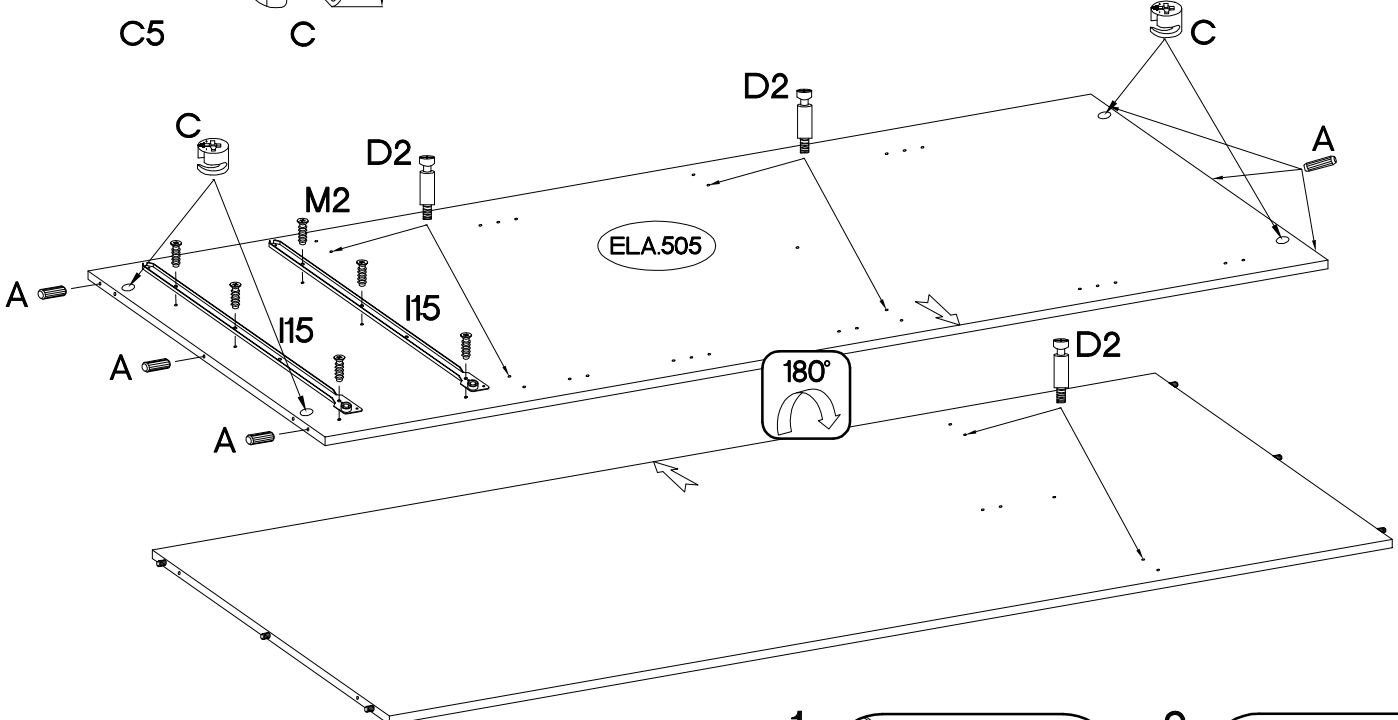
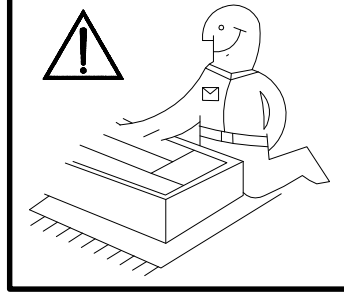



L=450mm  I15 2	+6,3x13mm  M2 12	+8x30mm  A 12	+15/12mm  C 8	L=20mm  D2 12
-------------------------	---------------------------	------------------------	------------------------	------------------------





$\varnothing 8 \times 30 \text{mm}$  A 24	L=20mm  D2 8	$\varnothing 15/12 \text{mm}$  C 8	 T3 6	$\varnothing 4.0 \times 16 \text{mm}$  P1 6	$\varnothing 15 \times 5 \text{mm}$  F4 4
--	---	---	---	--	--

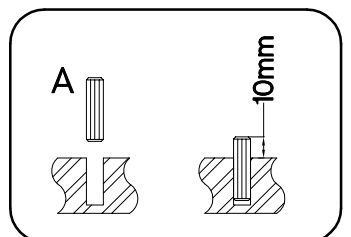
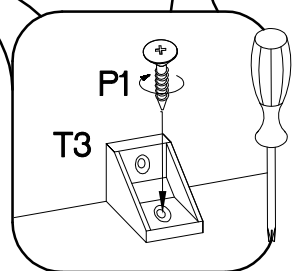
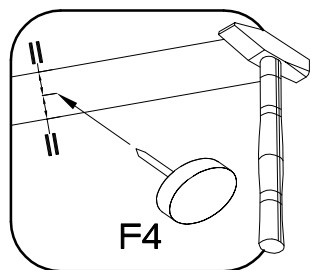
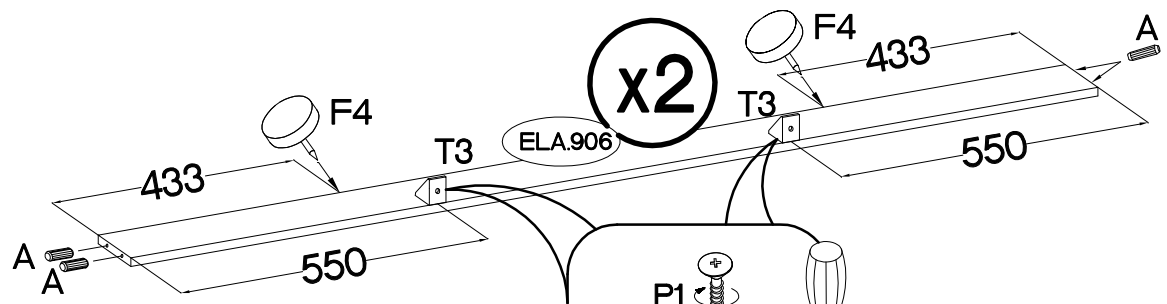
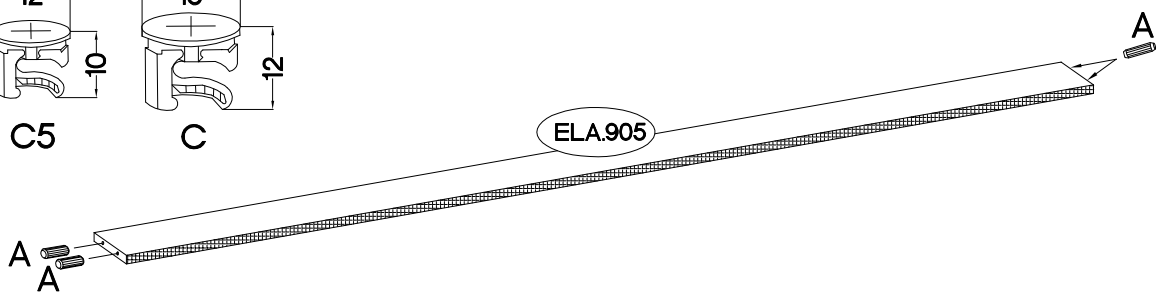
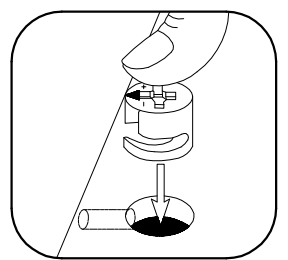
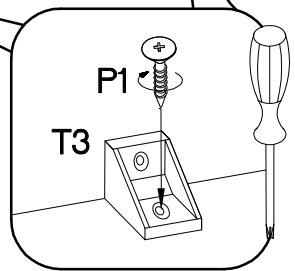
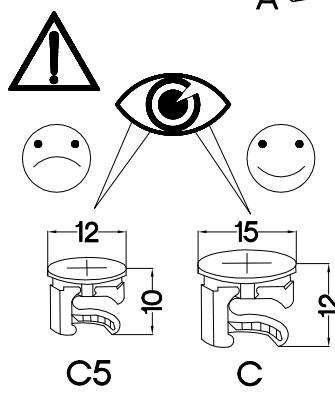
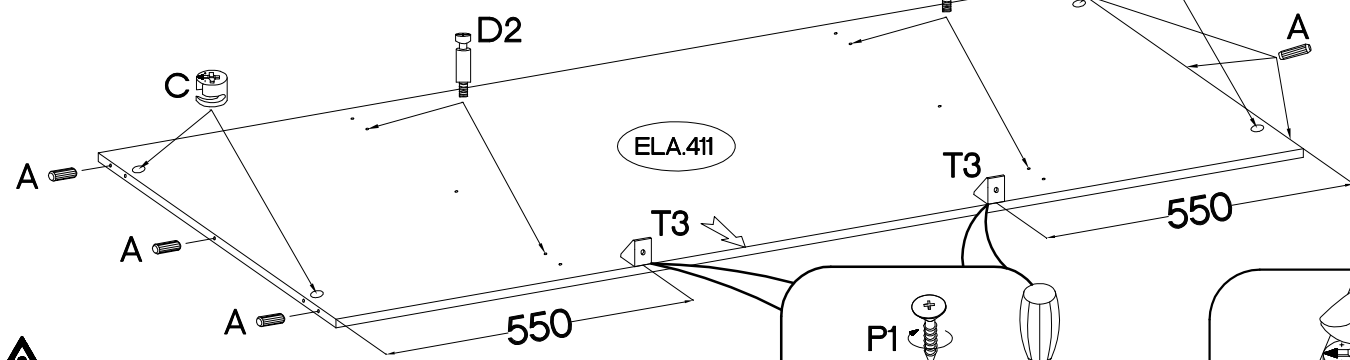
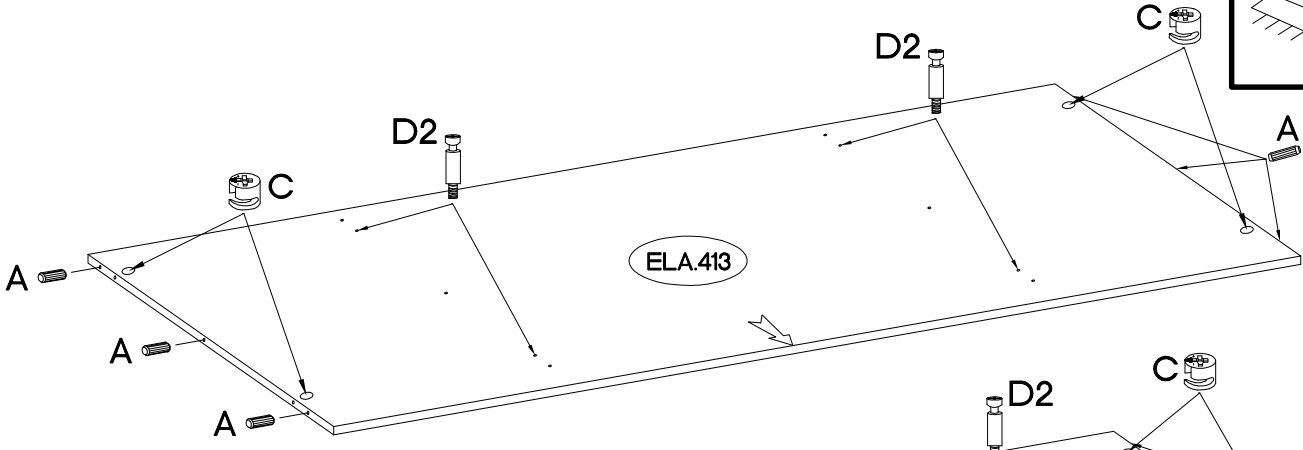
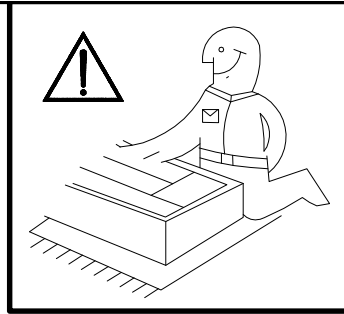

9

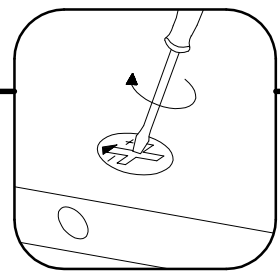
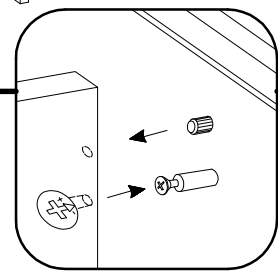
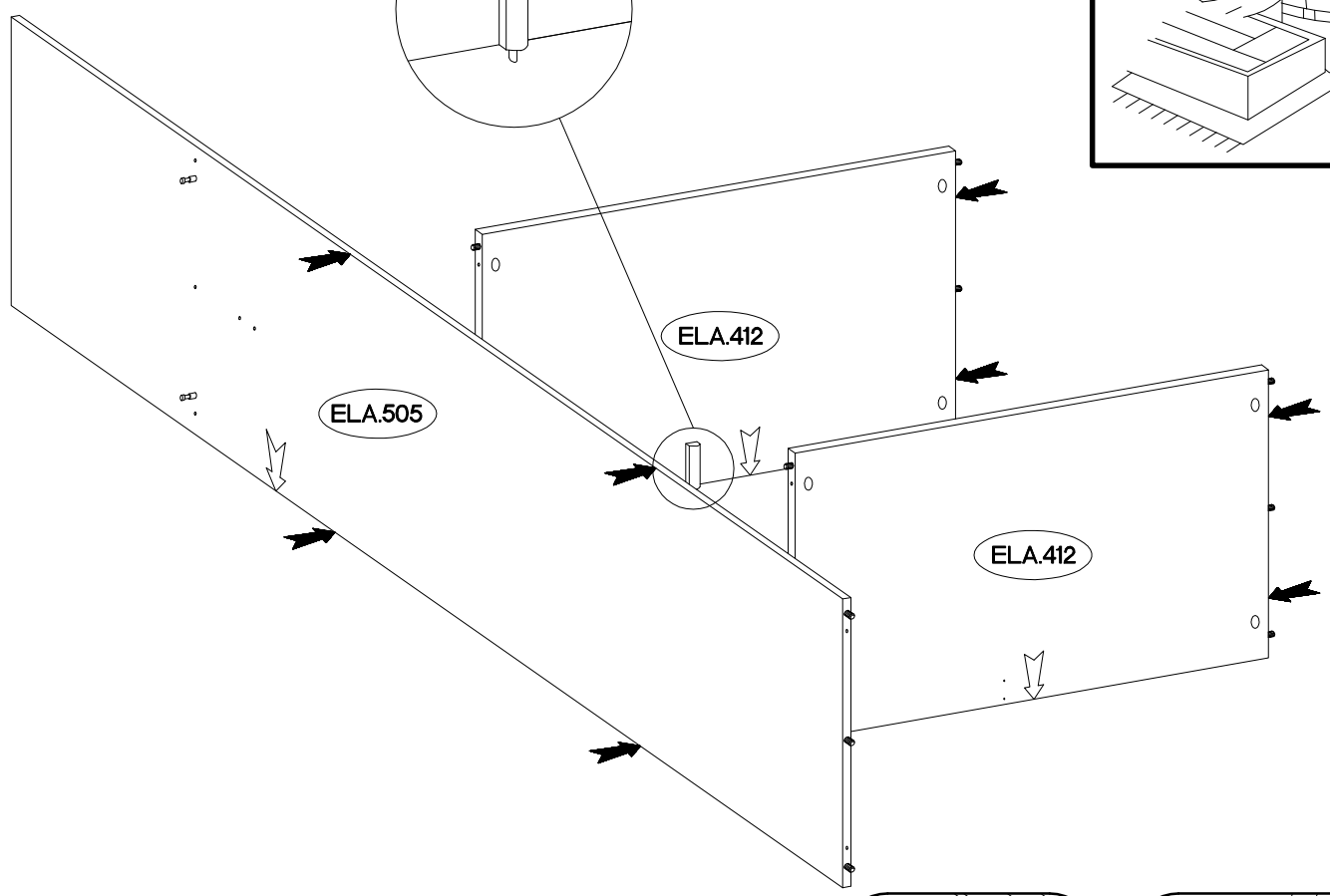
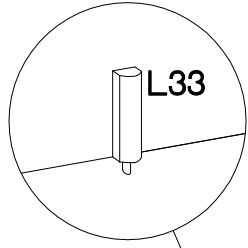
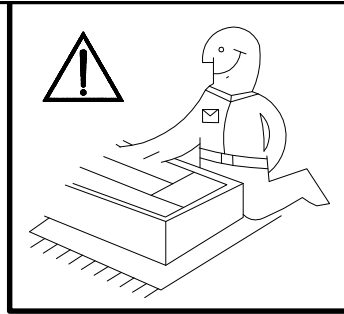

10

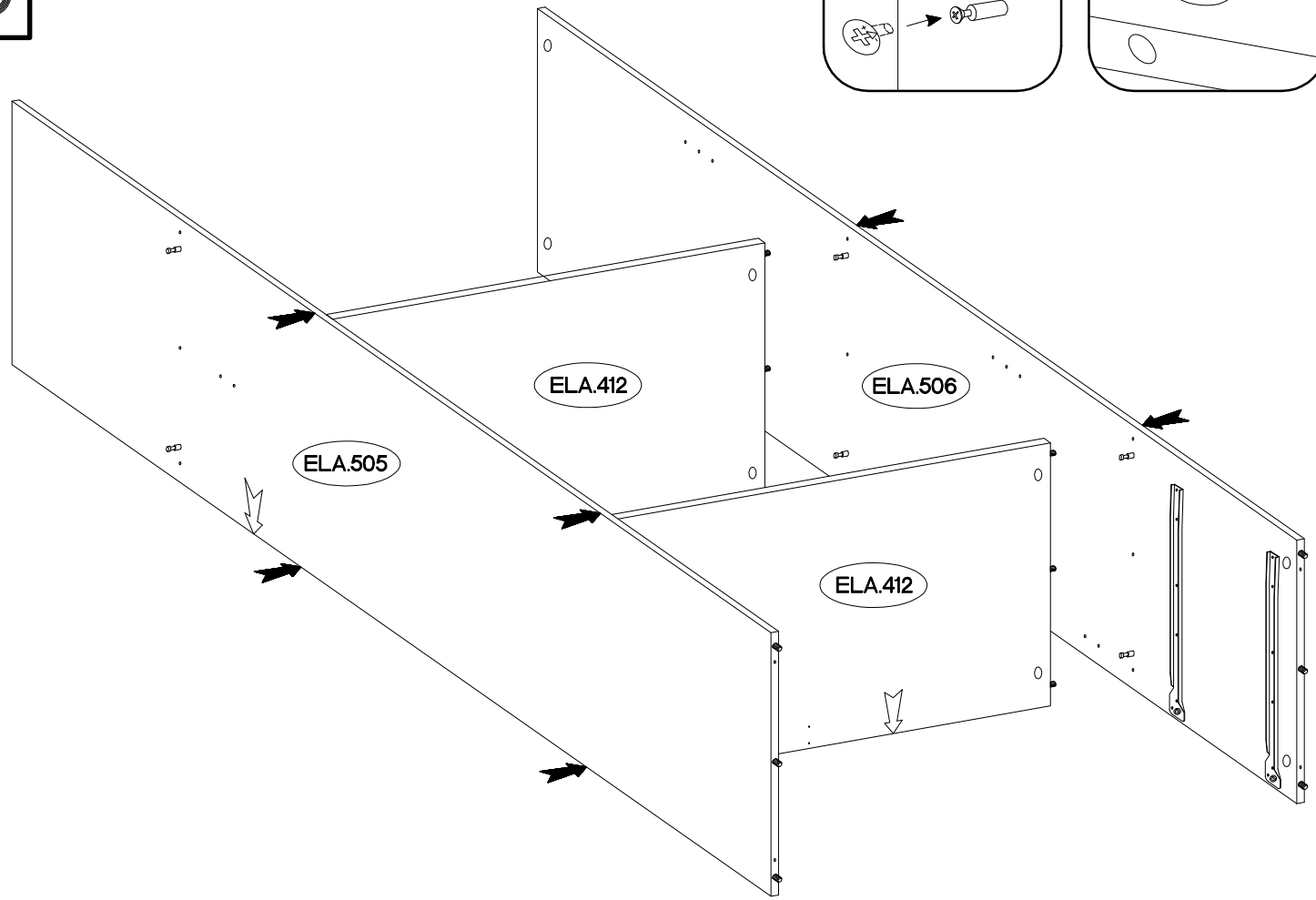

11

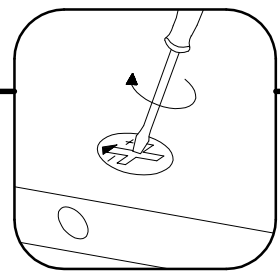
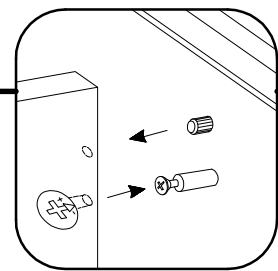
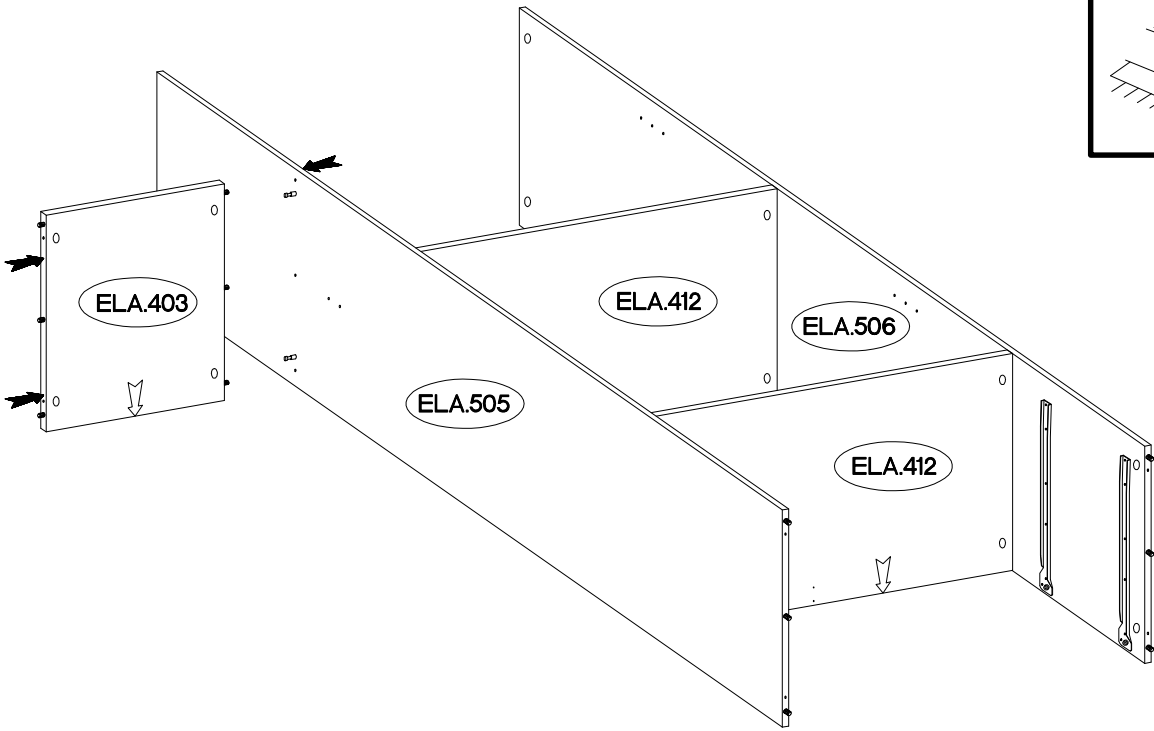
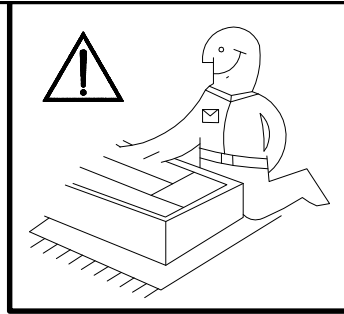

12

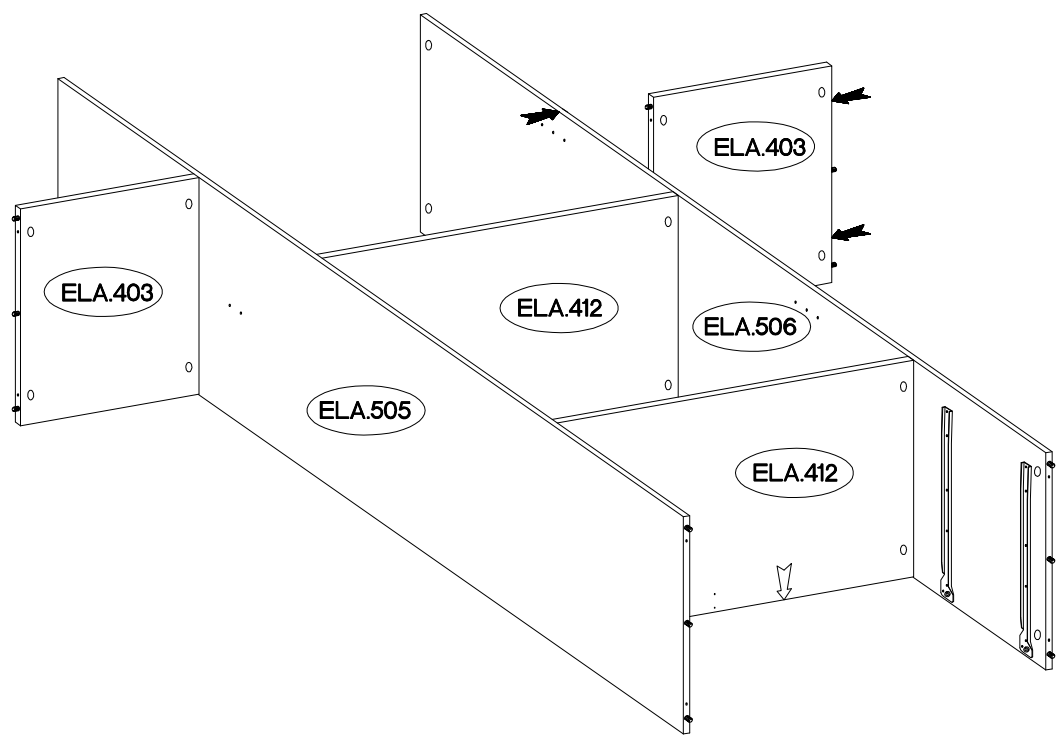

13

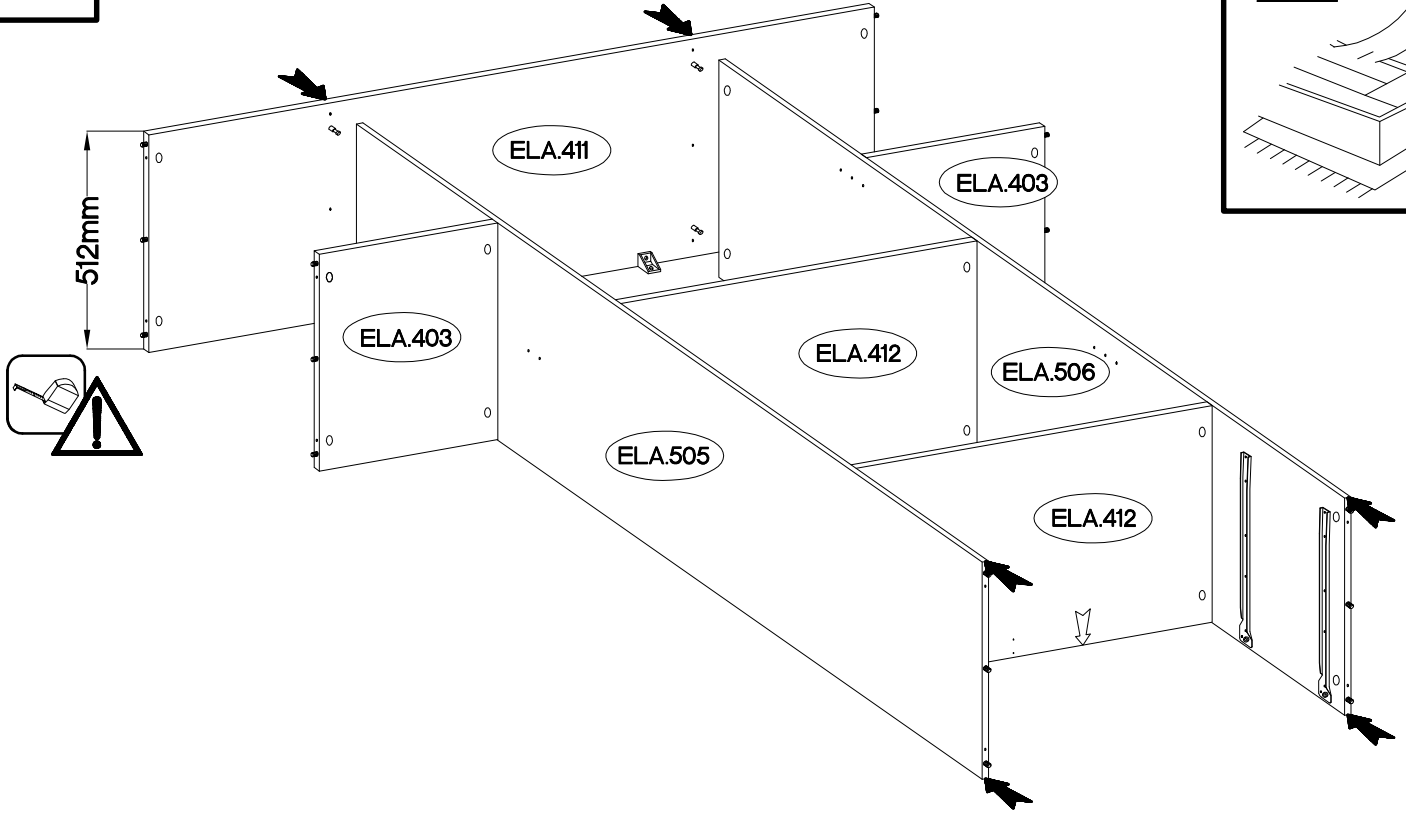
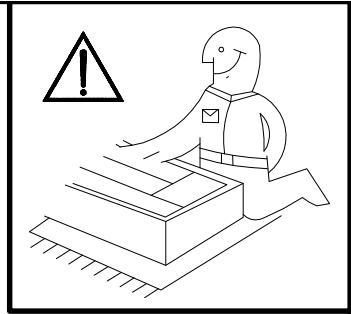

14

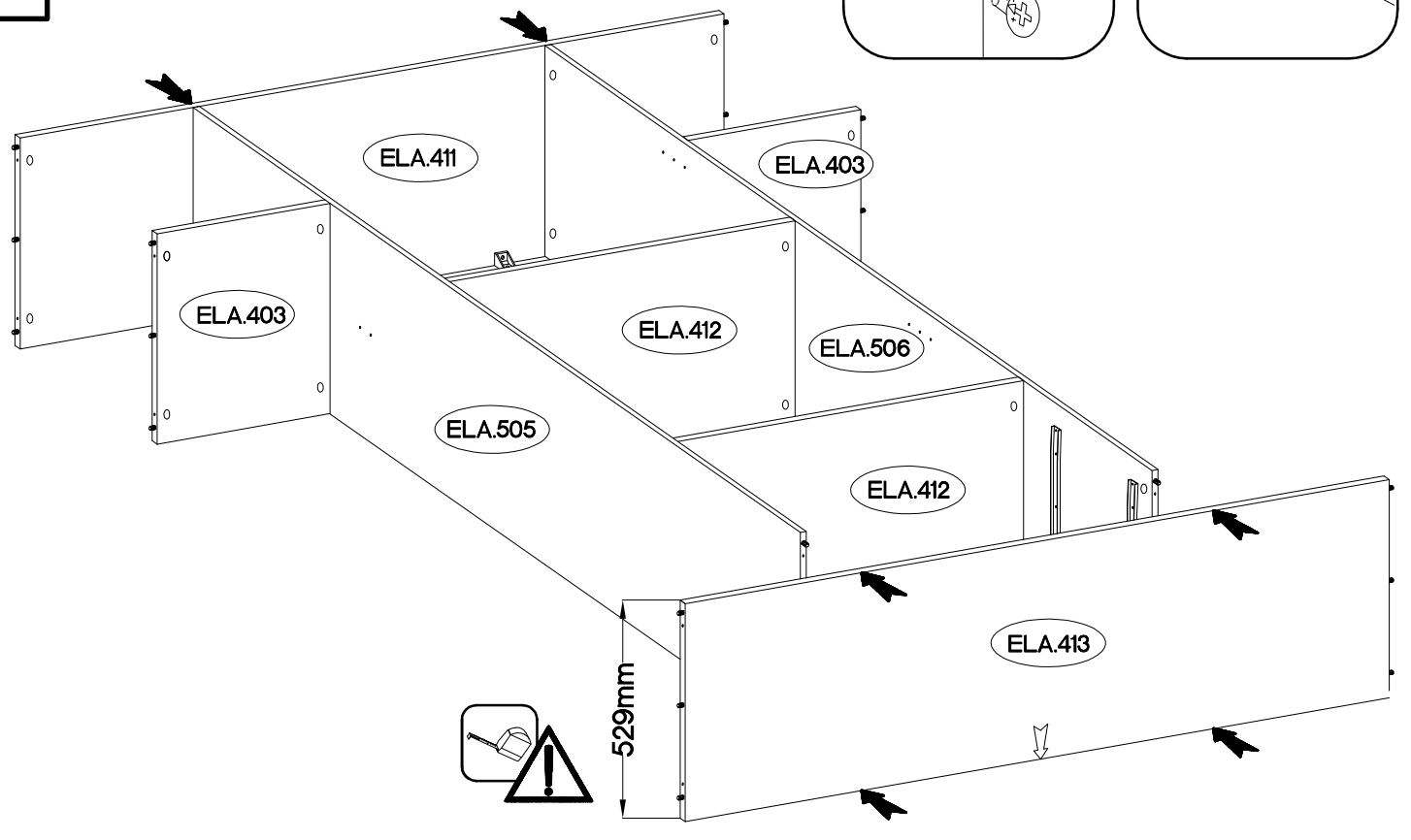
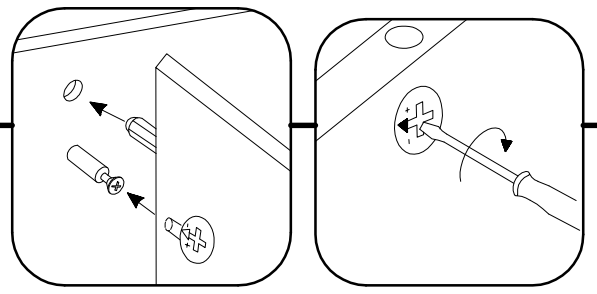

15

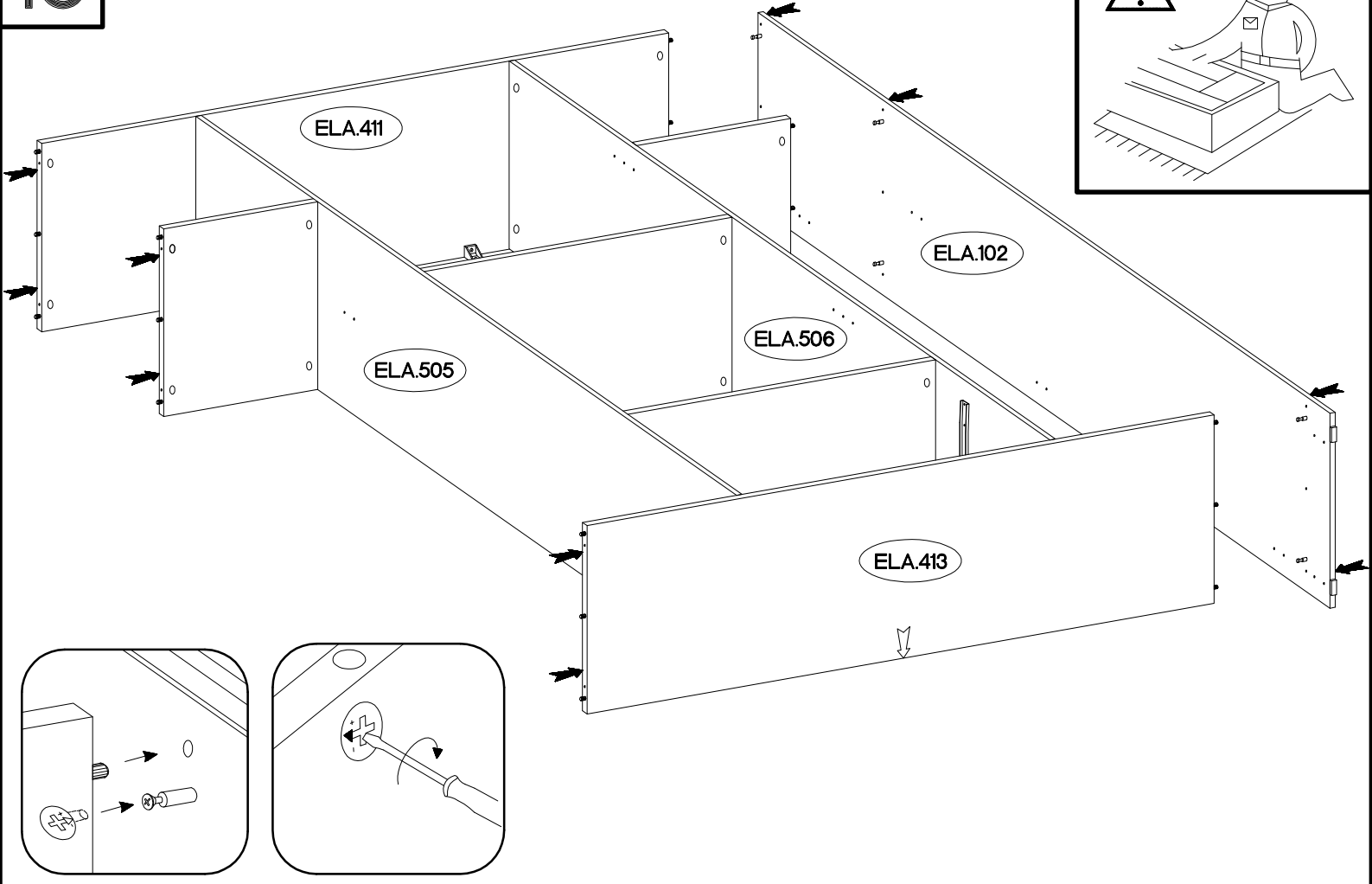
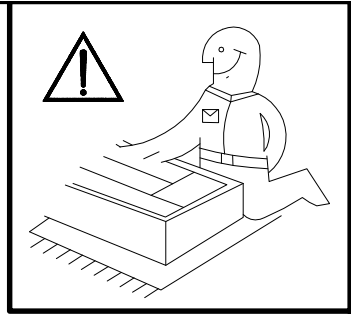



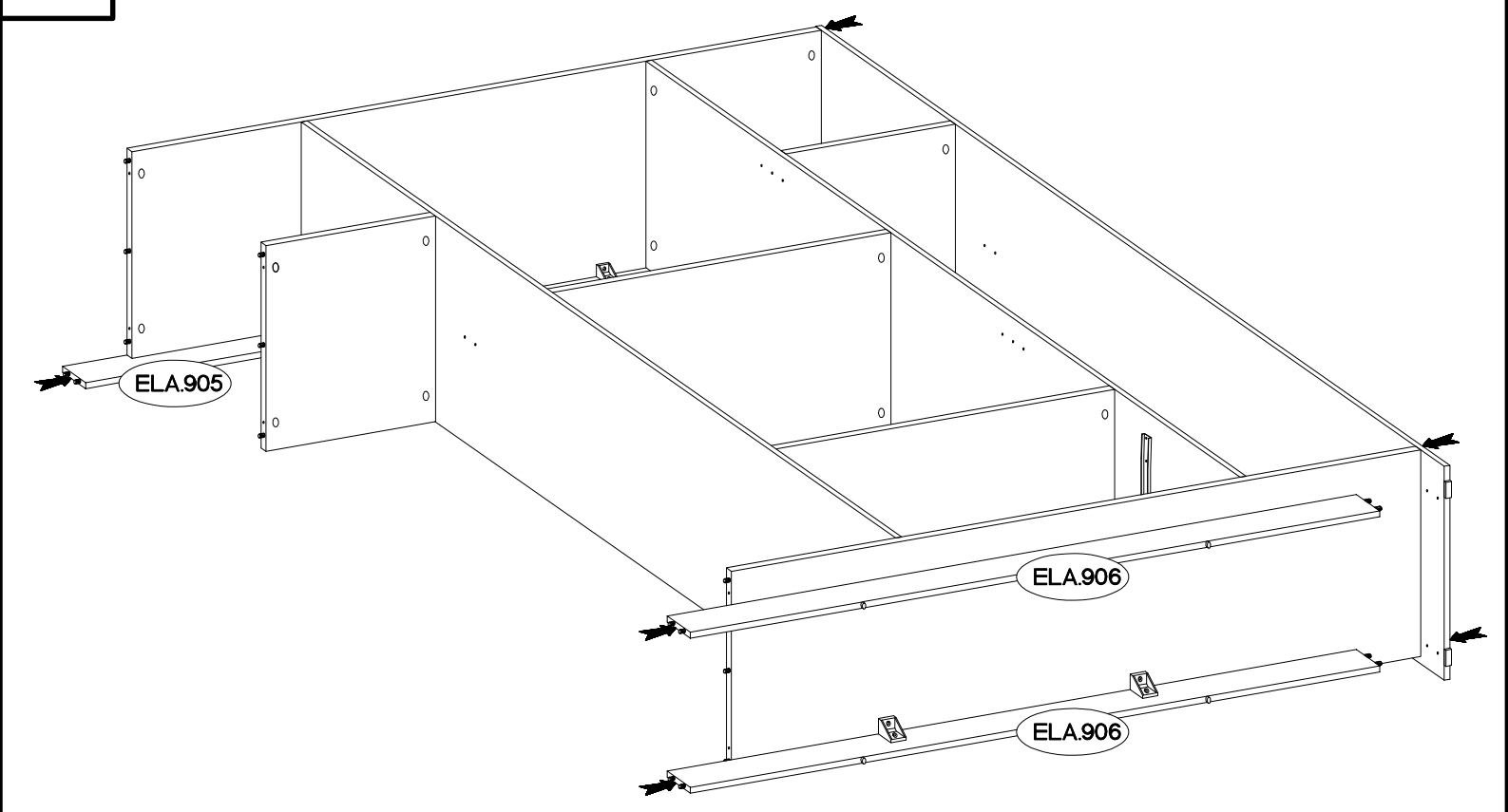

16

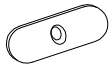

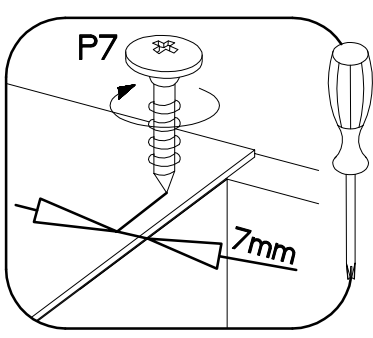
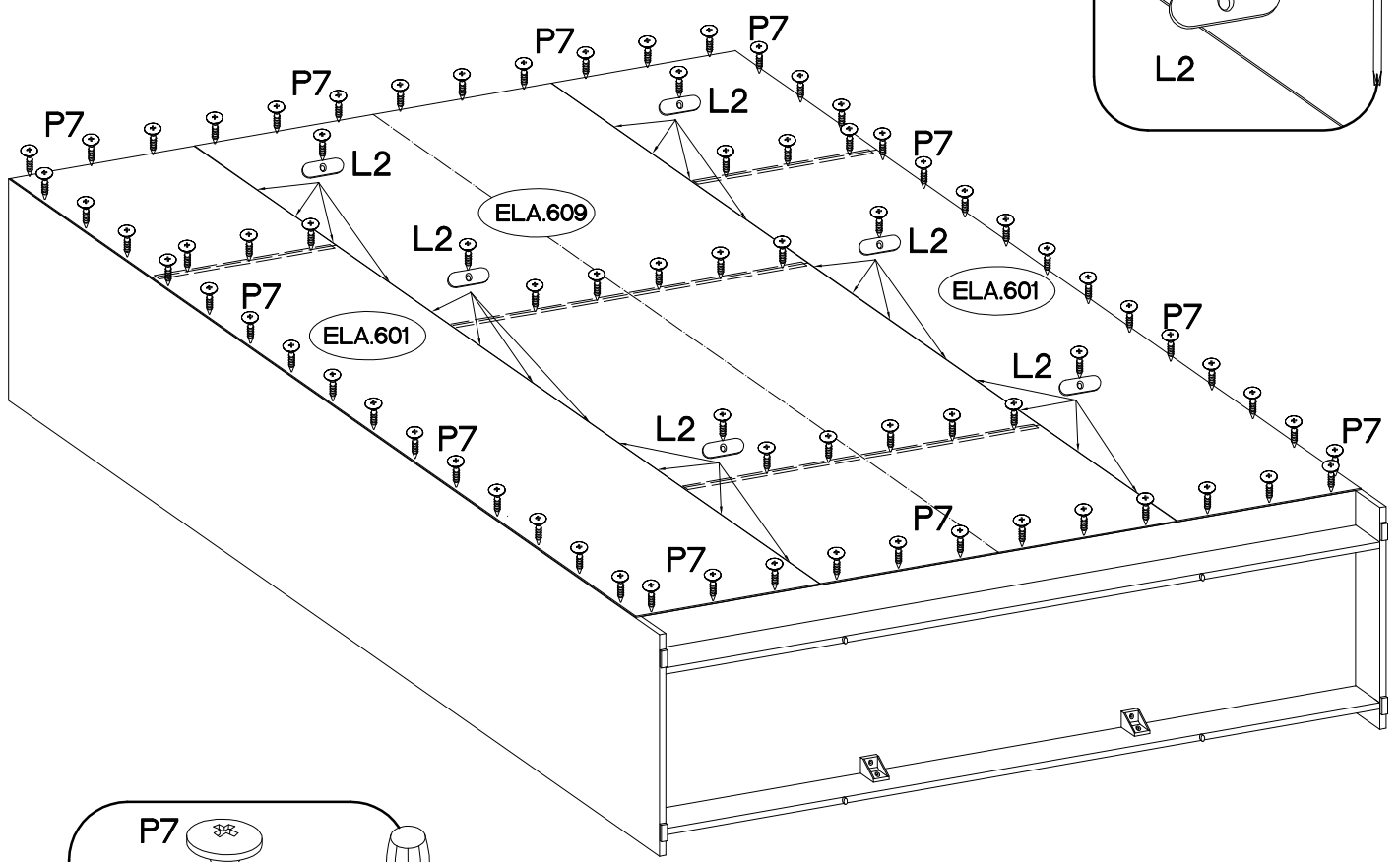
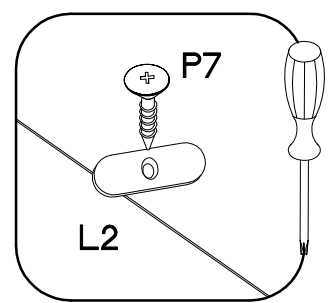
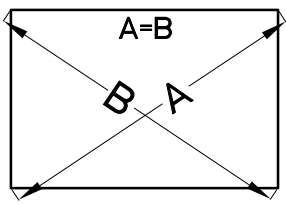
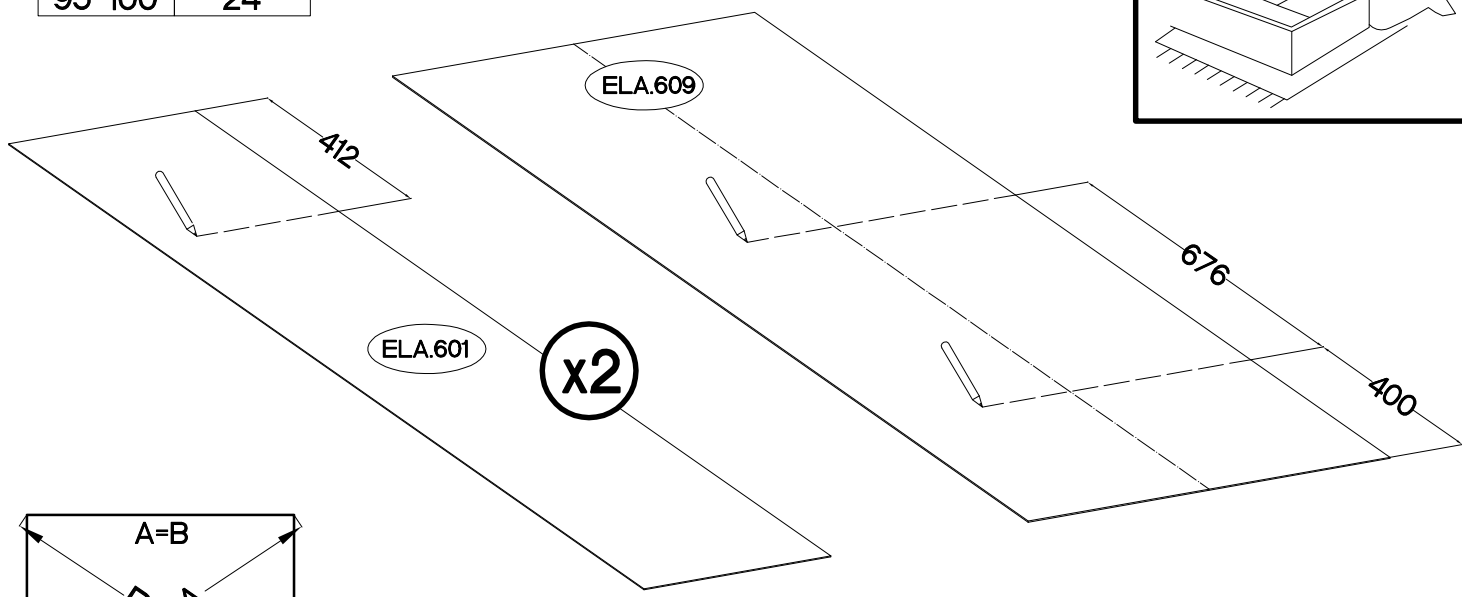
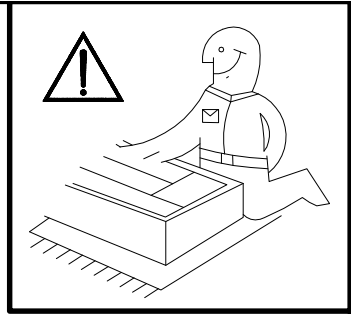

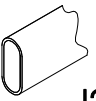



±3.0x20mm  P7 95-100	 L2 24
---	--

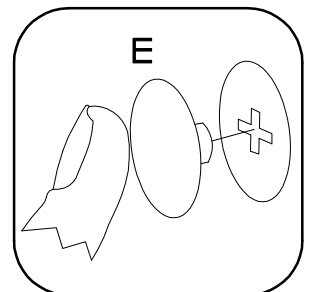
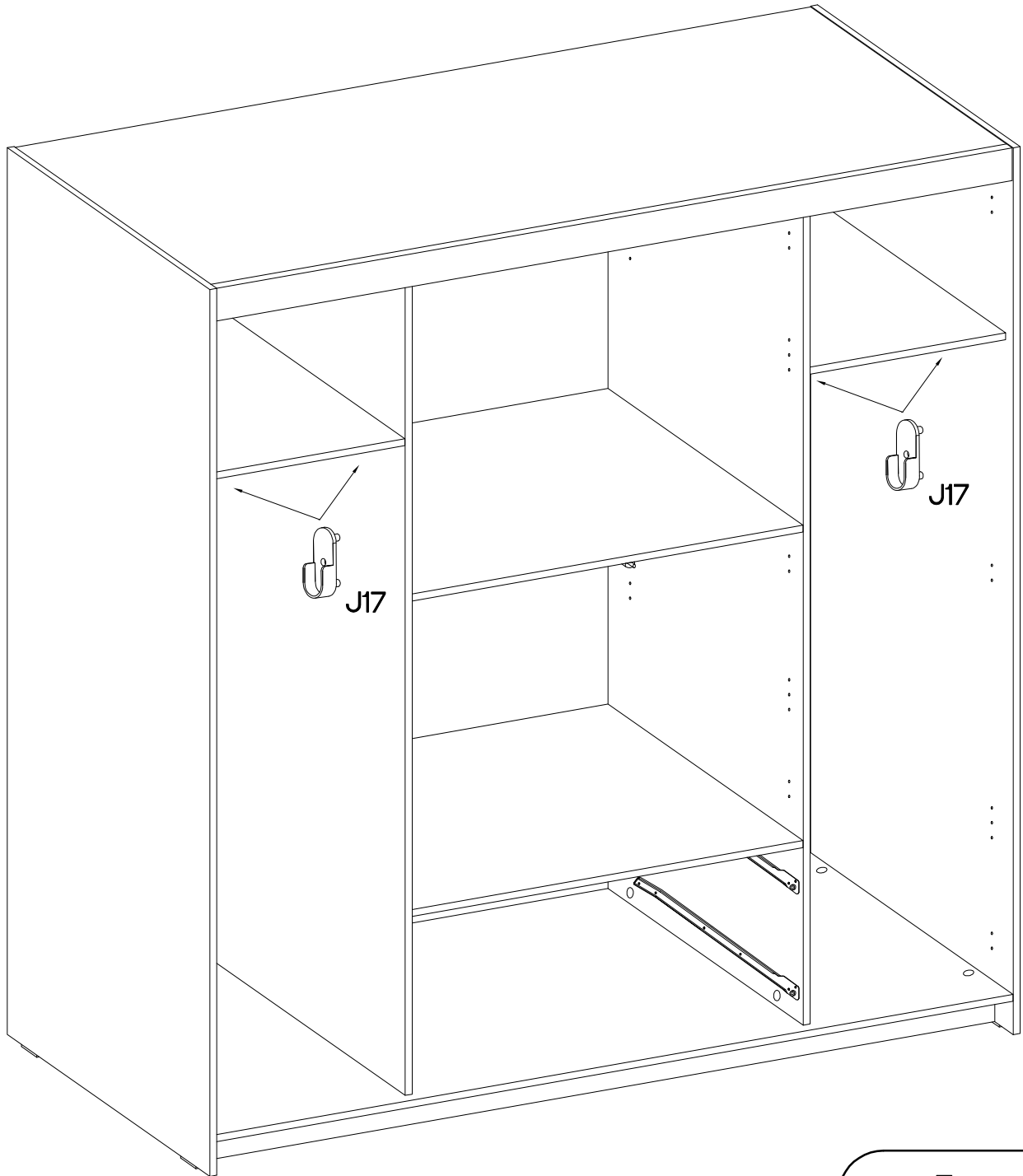
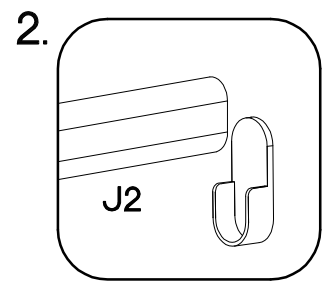
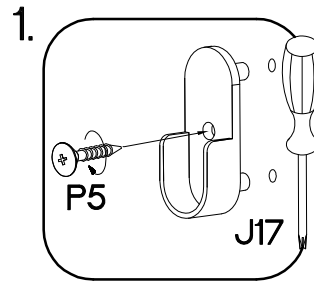



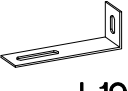

L=418mm  J2 2	 J17 4	φ3.5x13mm  P5 4	 E 28
--	--	--	---



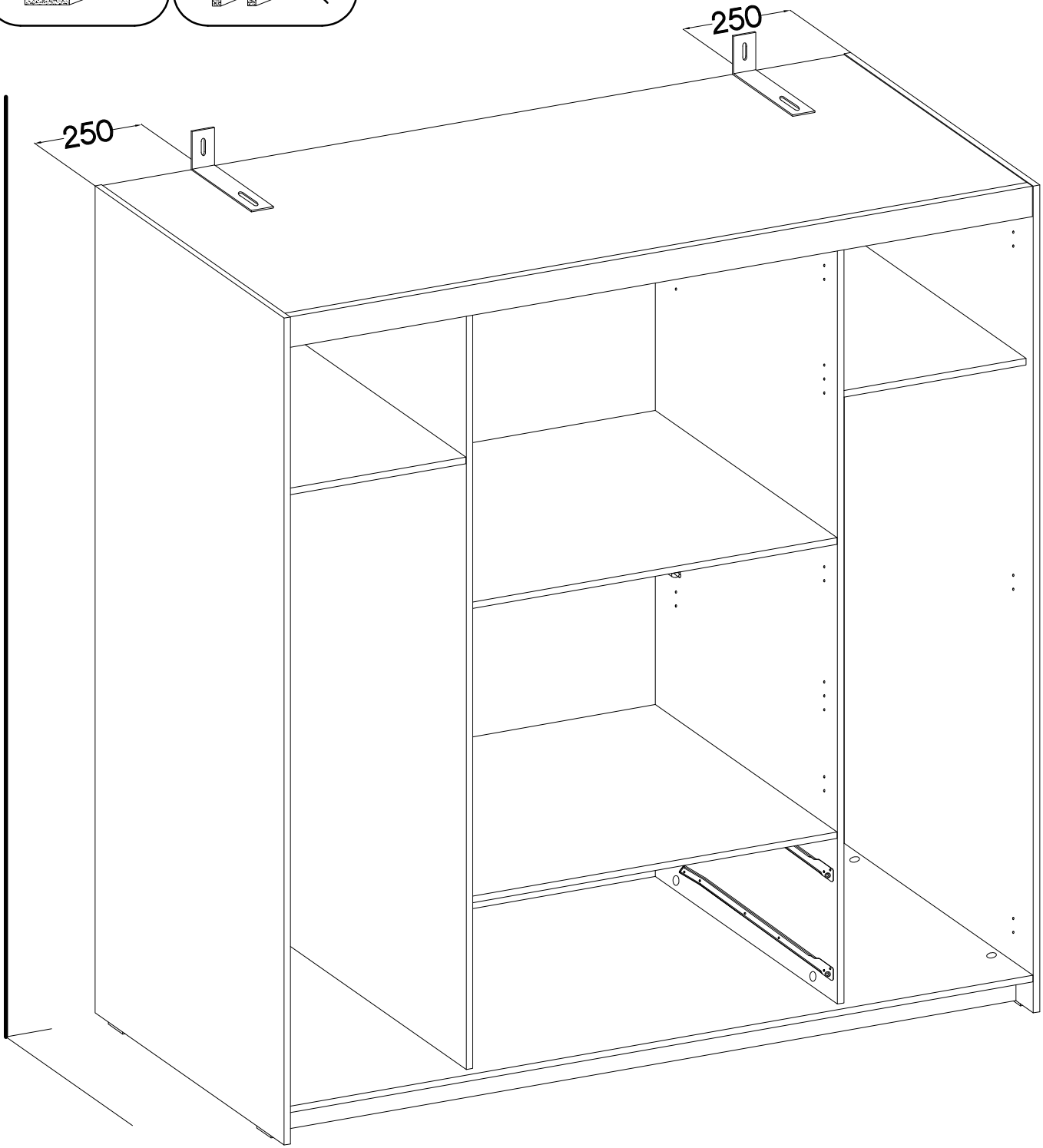
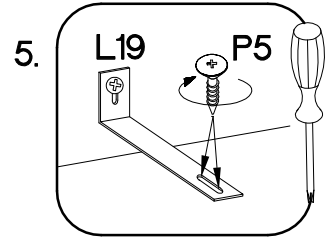
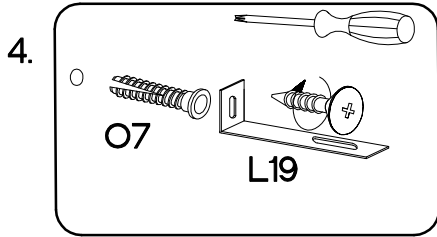
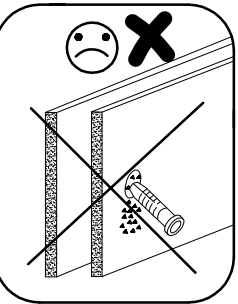
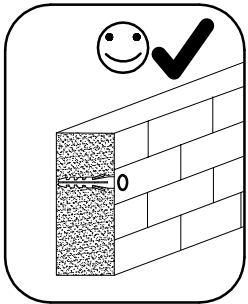
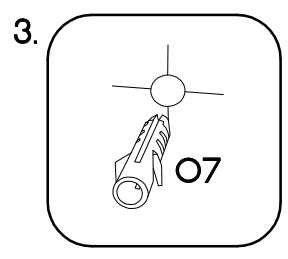
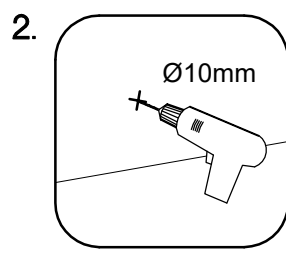
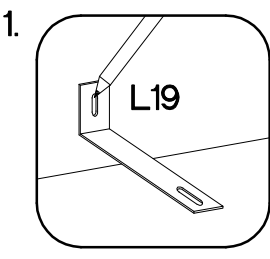

	†3.5x13mm	†5.0x60mm	†10x50mm
			
L19	P5	P12	O7
2	4	2	2

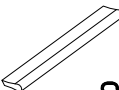

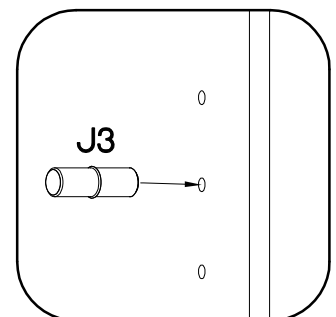
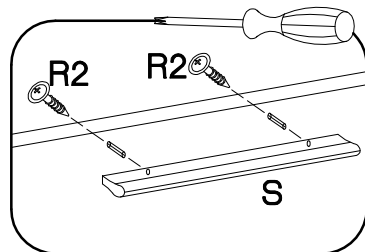
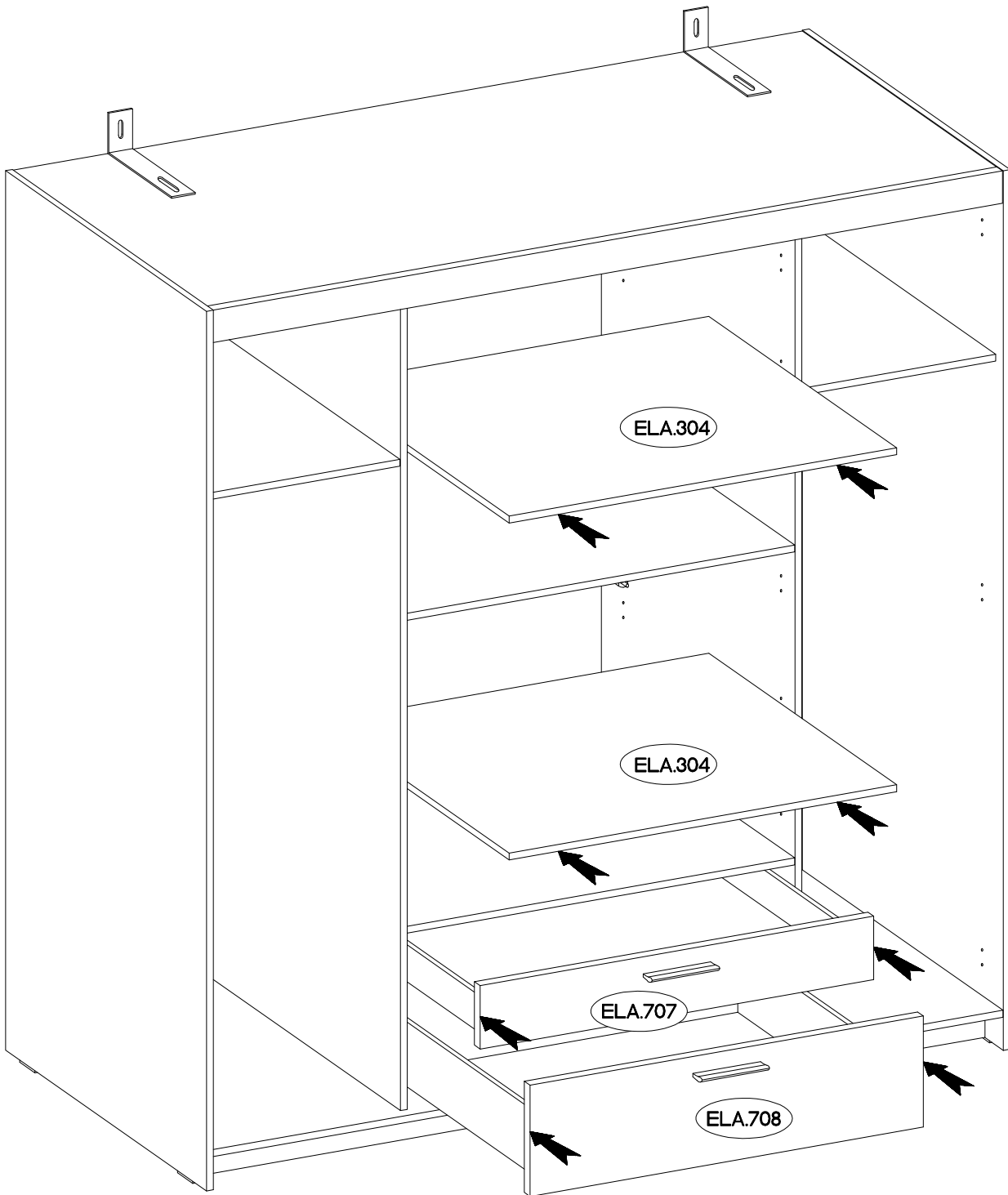

$\pm 5/16\text{mm}$  J3 8	L=128mm  S 2	$\pm 4.0 \times 30\text{mm}$  R2 4
--	---	---

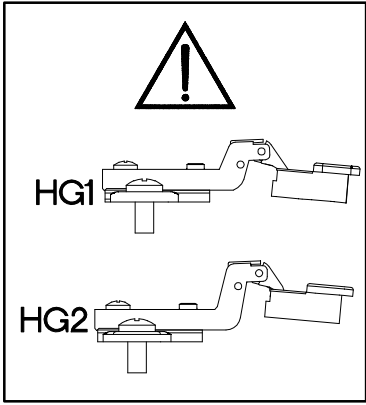

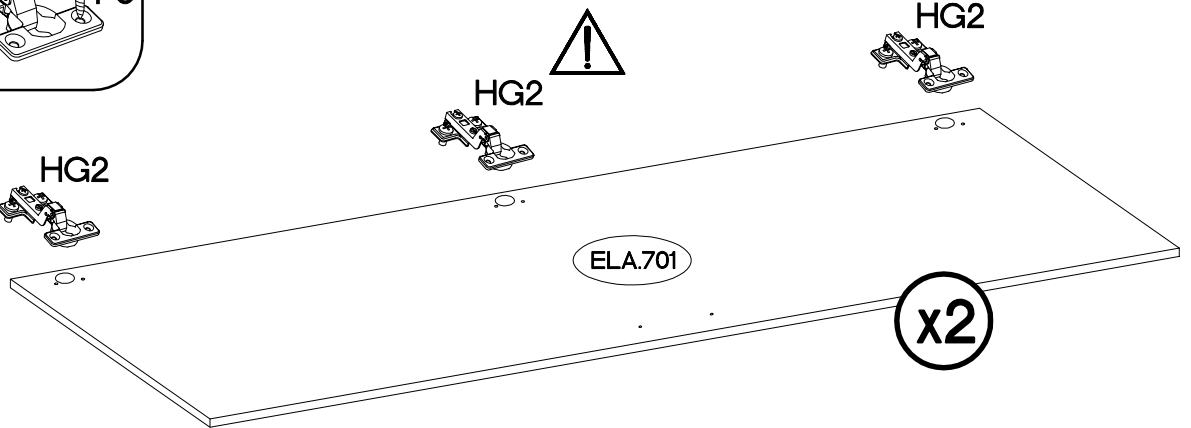
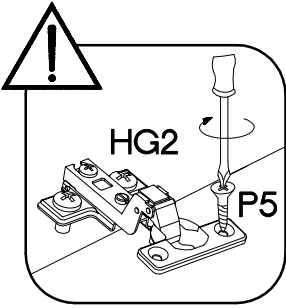
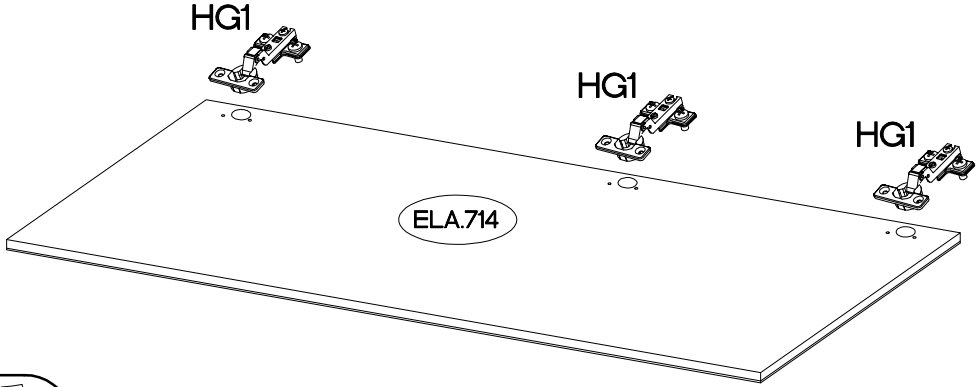
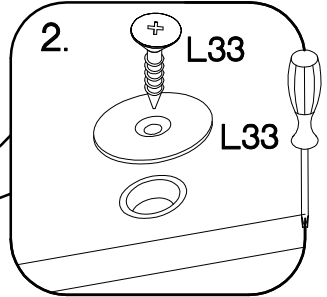
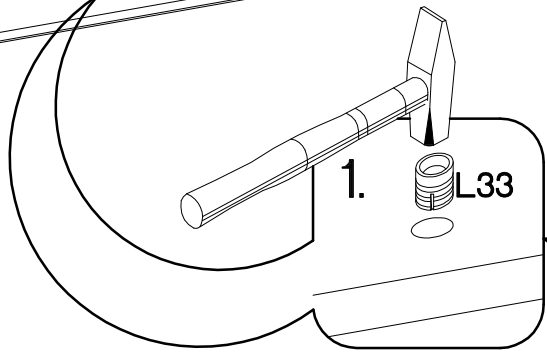
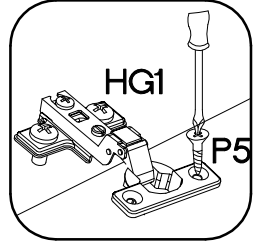
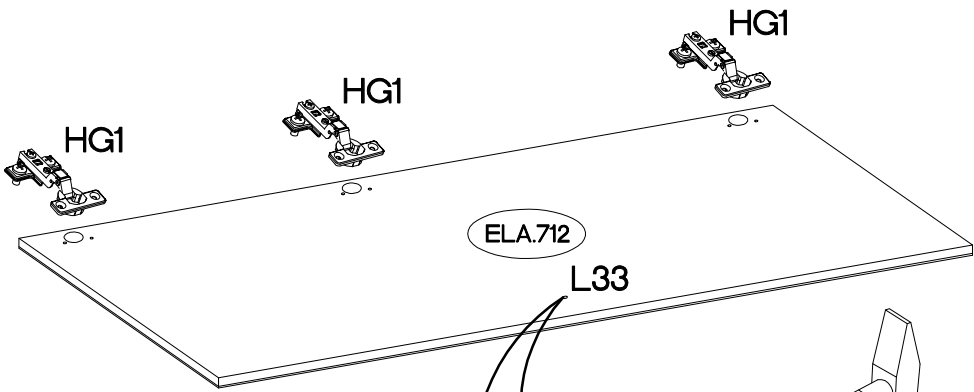
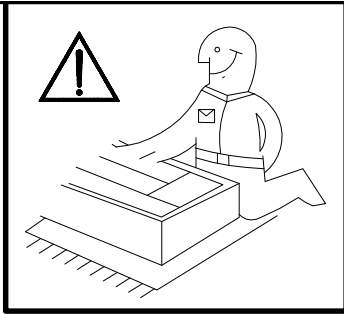

$\pm 35/9\text{mm}$ H=0	$\pm 35/16\text{mm}$	$\pm 3.5 \times 13\text{mm}$	
<b>HG1</b>	<b>HG2</b>	<b>P5</b>	<b>L33</b>
6	6	24	1

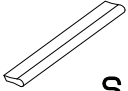

L=128mm	4.0x30mm
	
S	R2
2	4

