

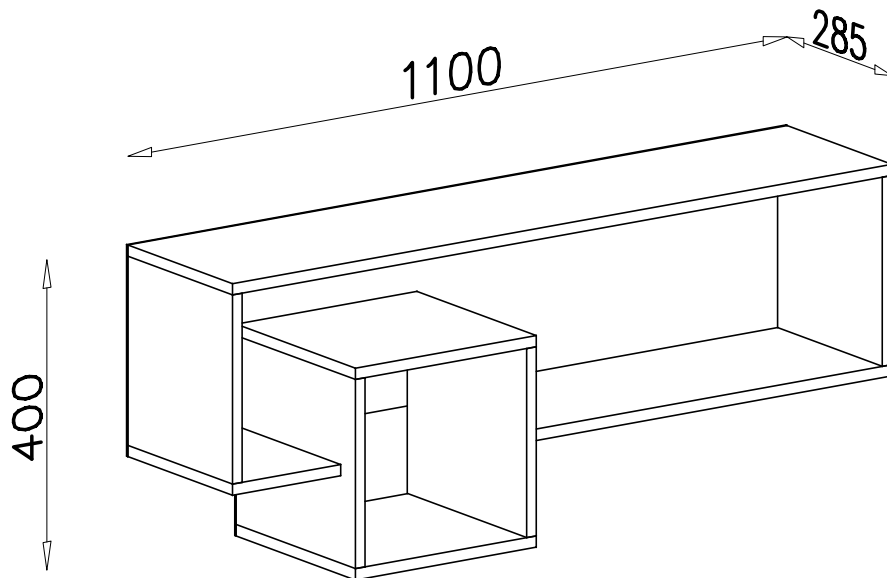

# NANO 12

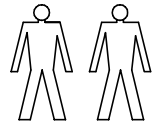

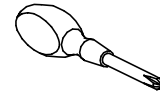
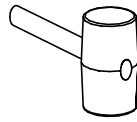
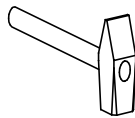
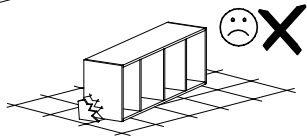
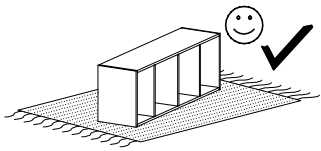

**G2**   
3x20 x30

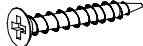
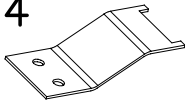
**G3**   
4x30 x4

**U14**   
x2

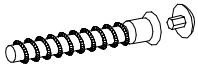
**W1**   
GLUE, LEIM, LEPIDLO, LIM x1

**A1**   
ø7x50 x10

**B7**   
ø8x30 x20

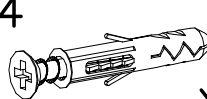
**U4**   
x4

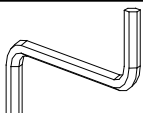
**W2**   
x1

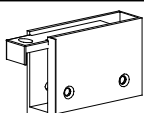
**U13**   
x2



IV

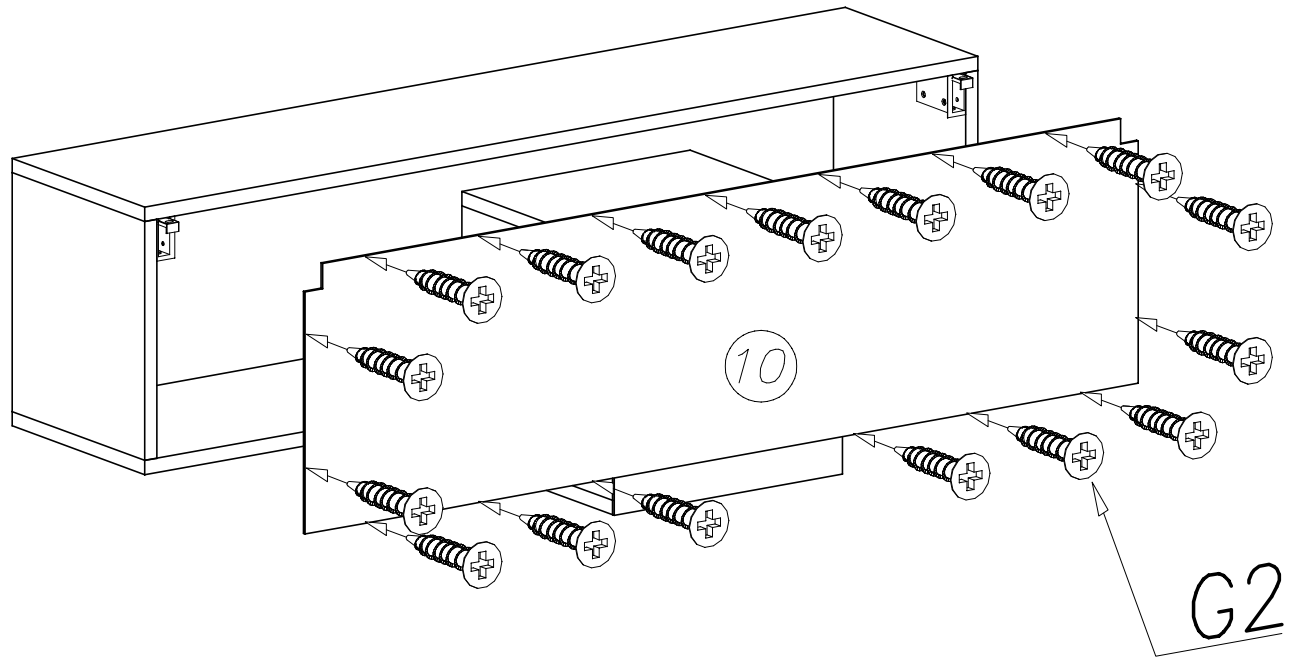

V

