

CAMPARI WNPP 6/36

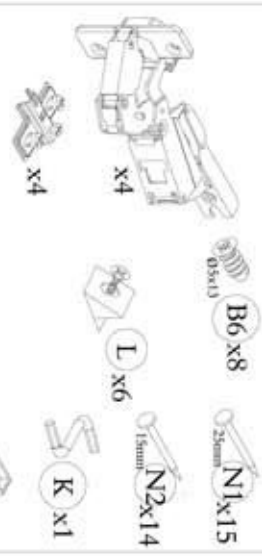

1.

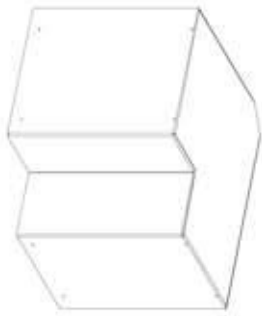
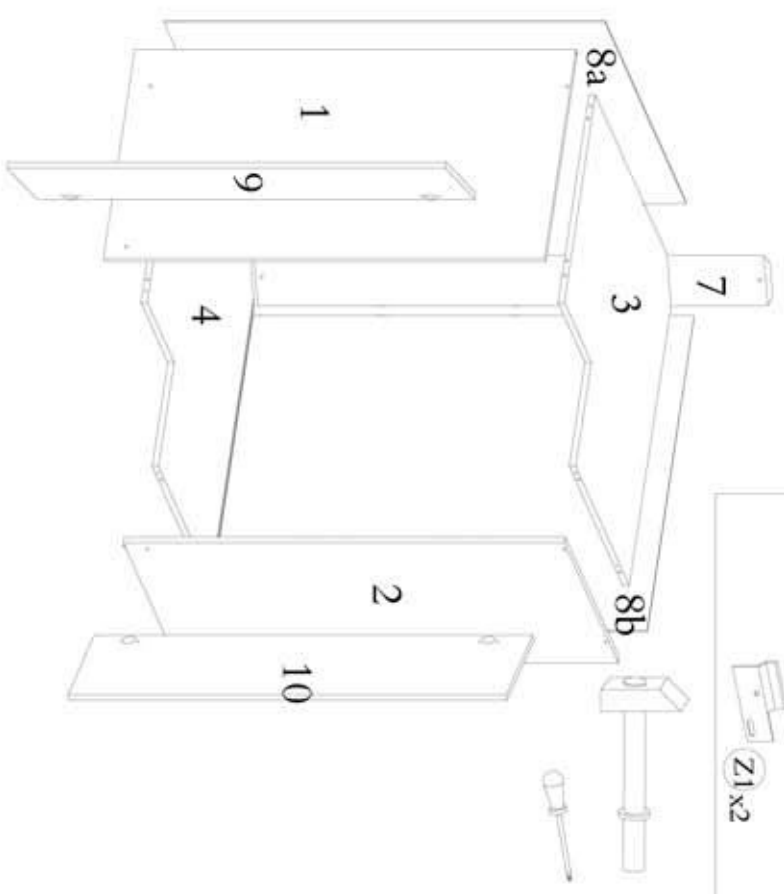

2.



3.



4.

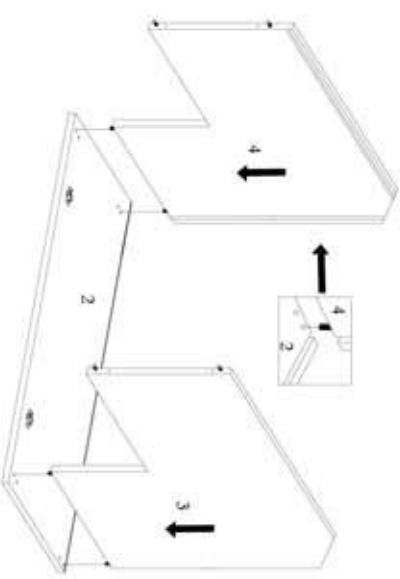

5.1

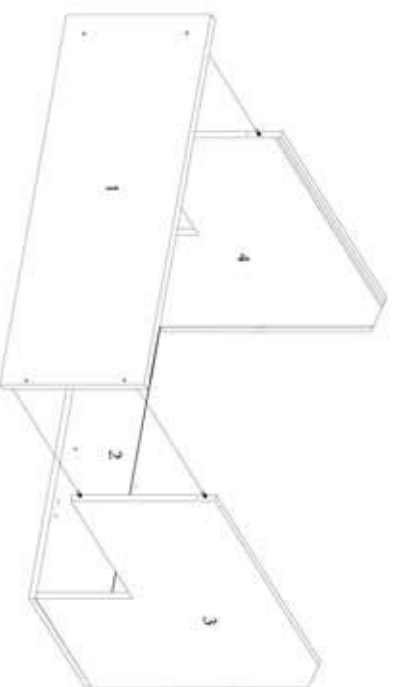

5.2

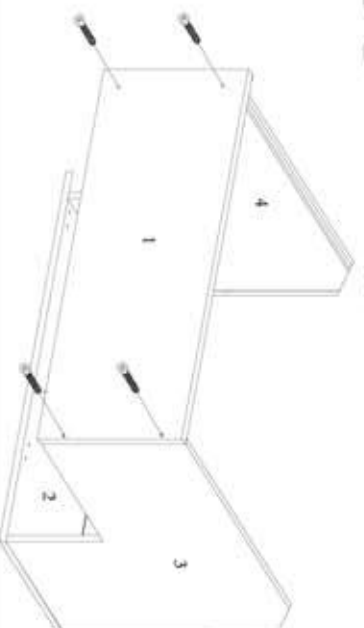

5.3

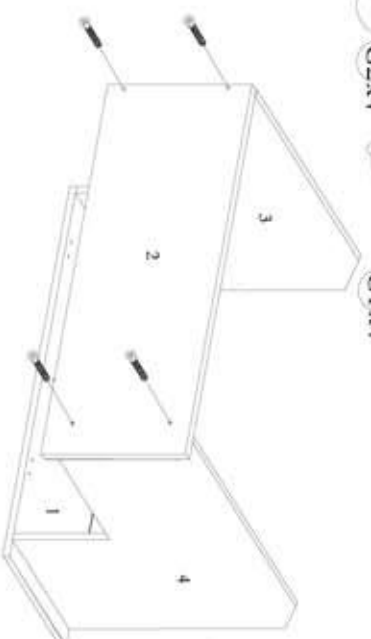

5.4

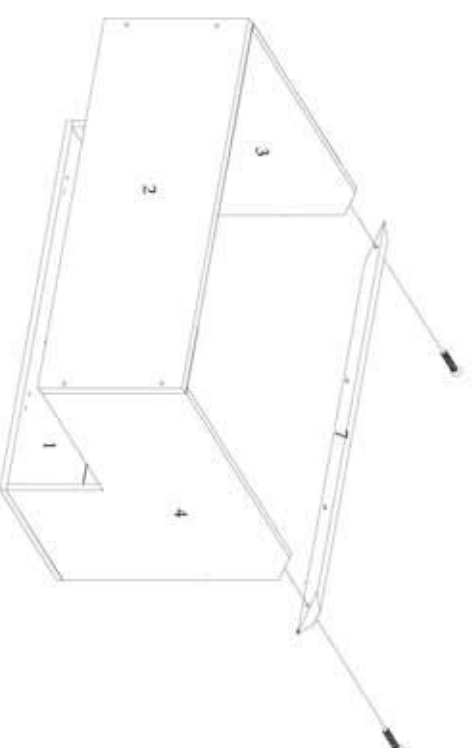

6.   L/x6  N1x15 

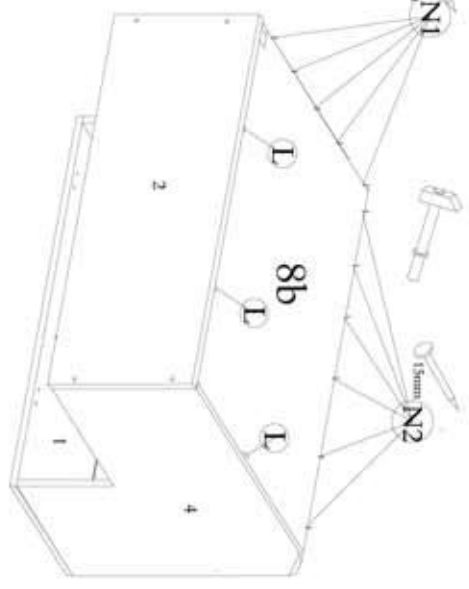
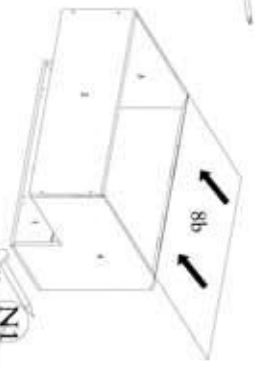
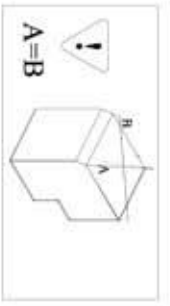

6.1

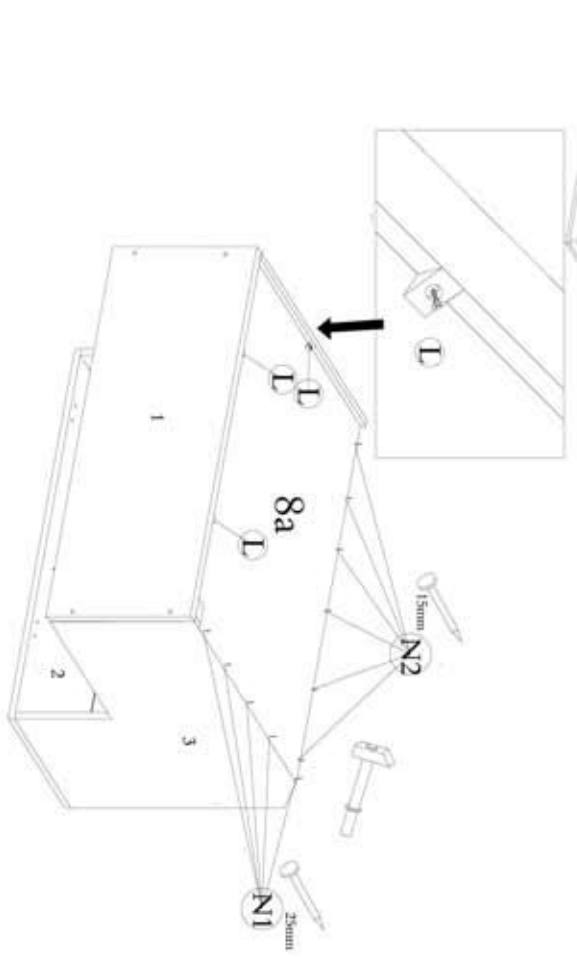

7. 

 B3x4  Ø5x13  B6x8

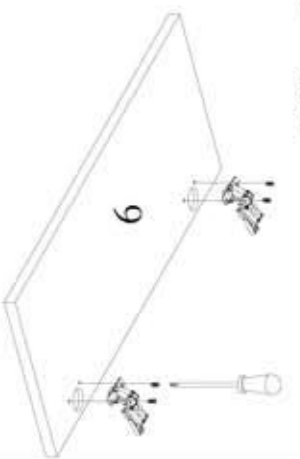
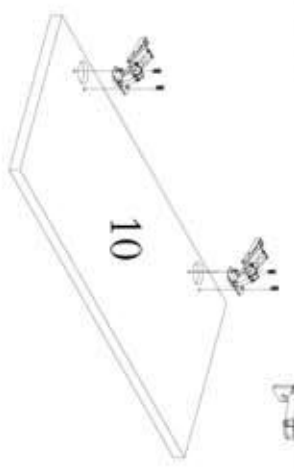

8.

 P2x4
Ø4x30

 P1x1

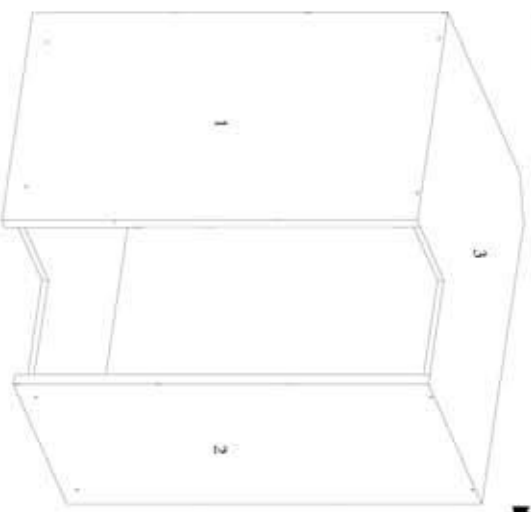
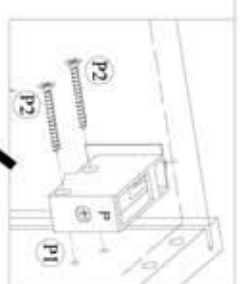
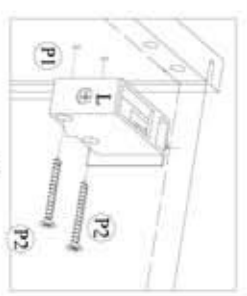

9.

