

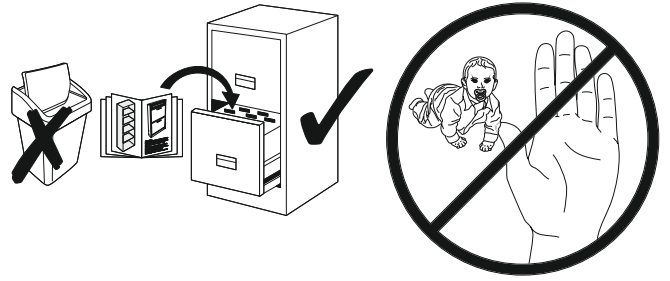

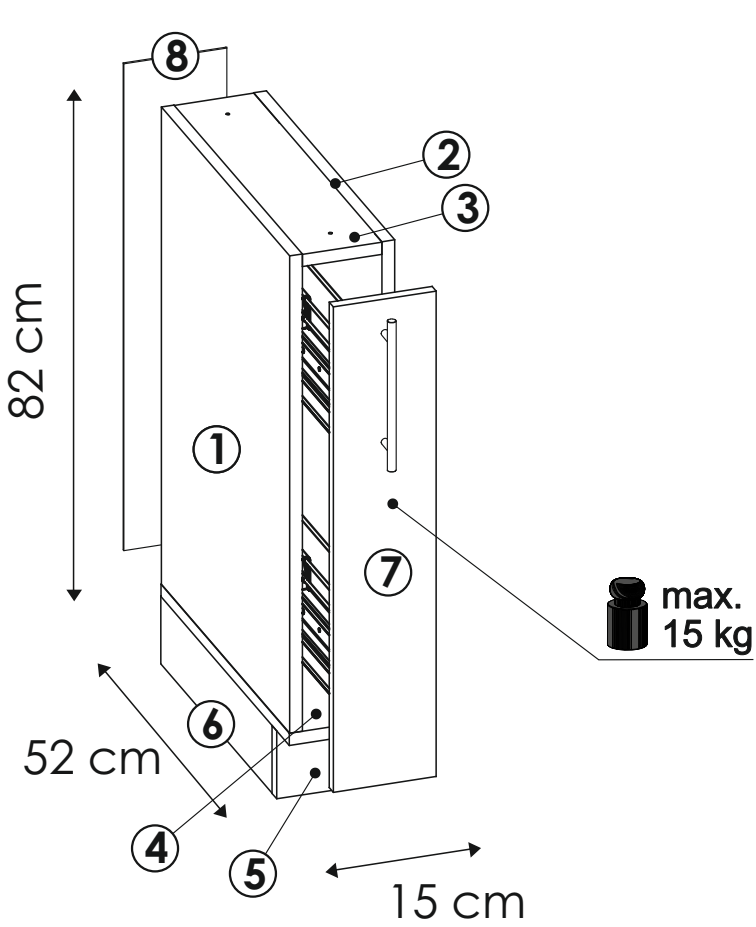

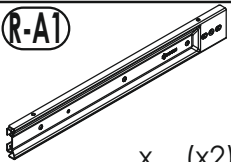



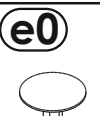

D1K 15

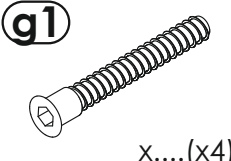
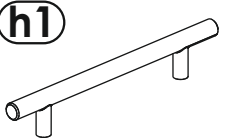

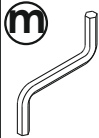
(R-A1)  x... (x2)	(R-C5)  4x14 x... (x14)	(a1)  8x35 x... (x8)	(e0)  x... (x4)	(e1)  x... (x4)	(f1)  x... (x4)			
(g1)  x... (x4)	(h1)  x... (x1)	(i5)  3,5x30 x... (x2)	(k3)  4x22 x... (x2)	(m)  x... (x1)	(n1)  3x16 x... (x20)	(n2)  3,5x16 x... (x14)	(o1)  x... (x2)	(o2)  x... (x3)

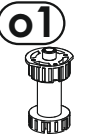
C1  1/1

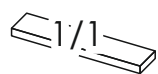
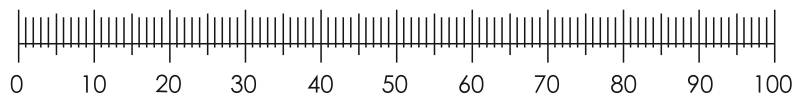

- | | |
|-------|-------|
| ① -C1 | ⑥ -C1 |
| ② -C1 | ⑦ -C1 |
| ③ -C1 | ⑧ -C1 |
| ④ -C1 | ⑨ -C1 |
| ⑤ -C1 | |

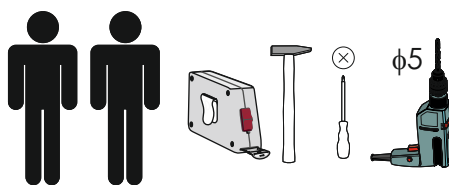

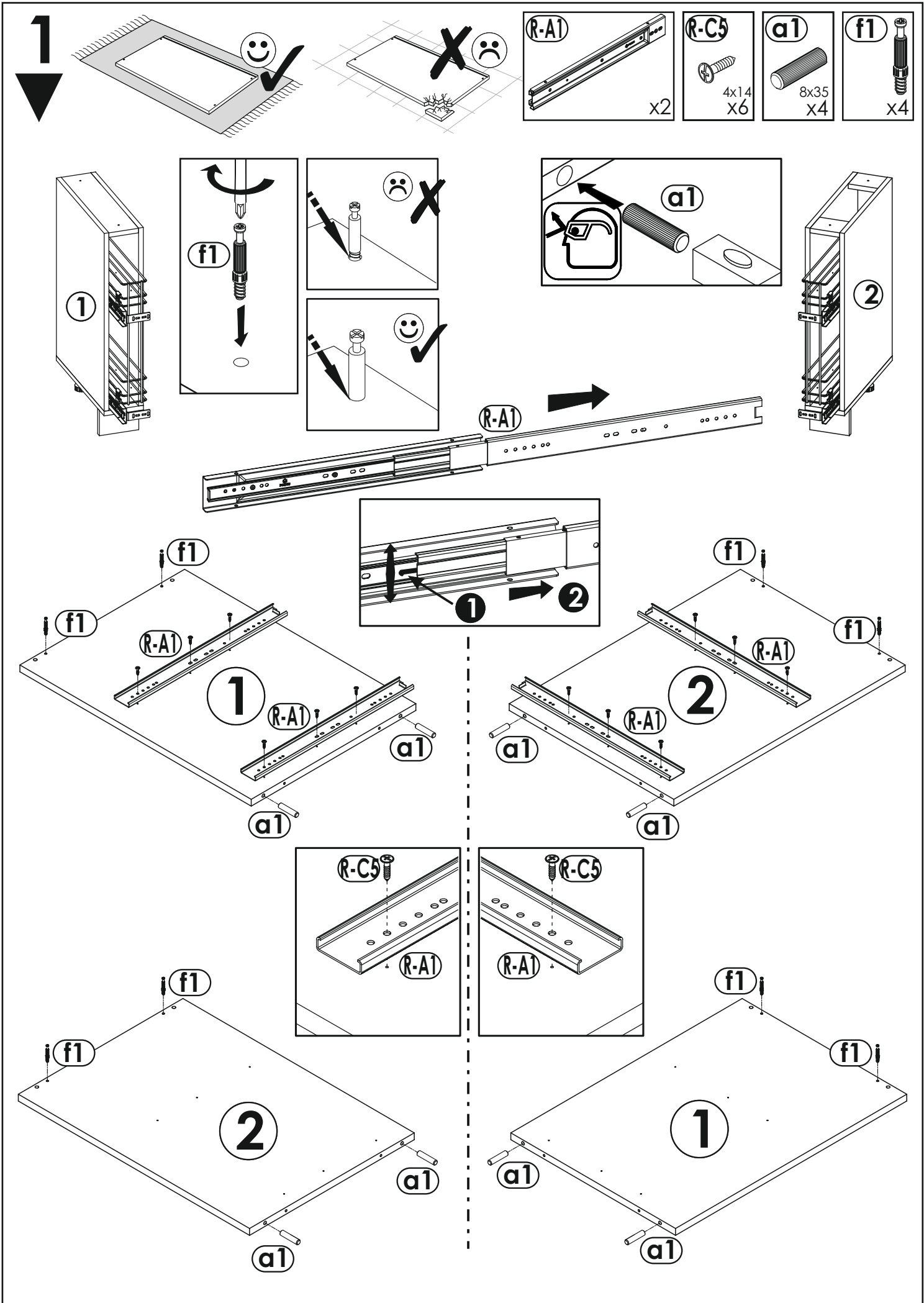

2

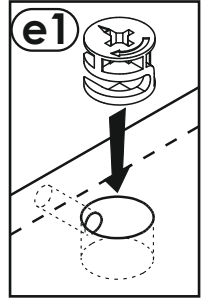
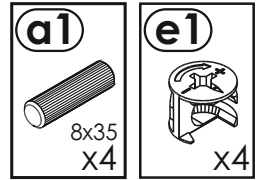
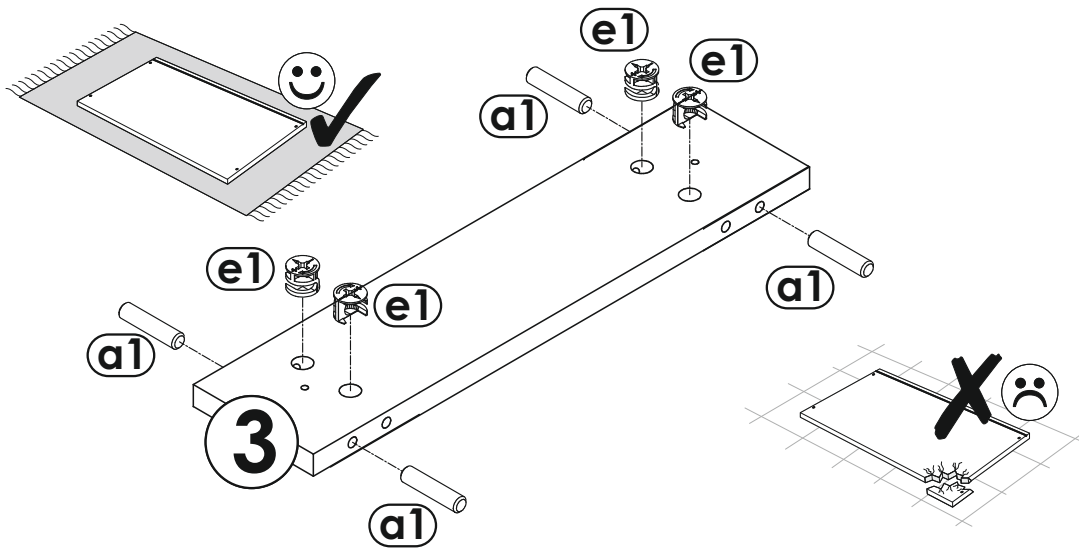

3

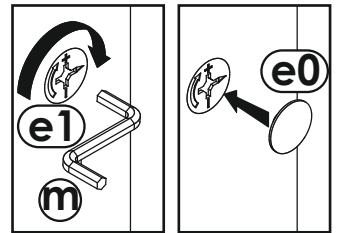
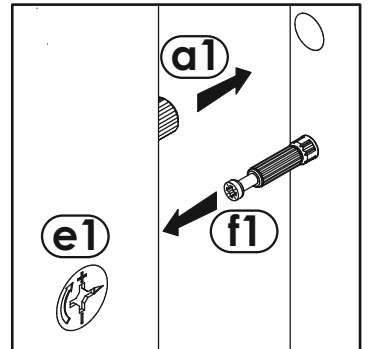
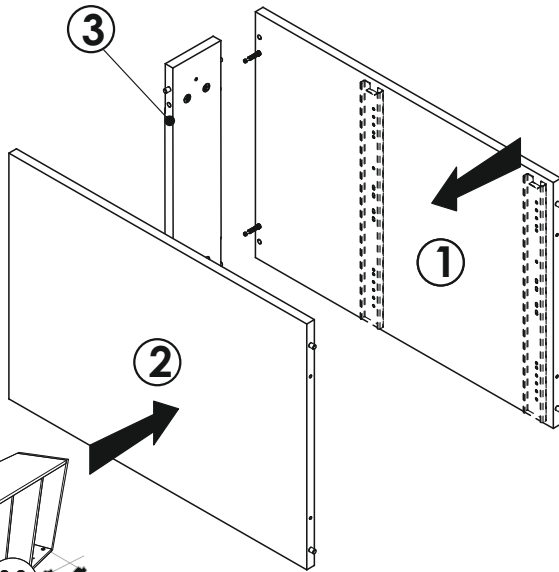
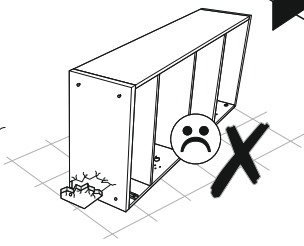
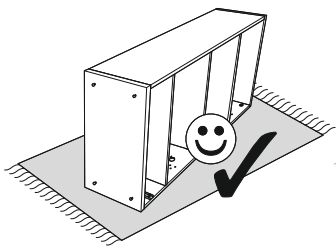
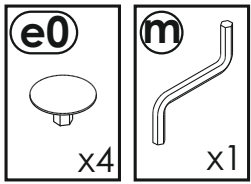

4

