

# DUCA DC I

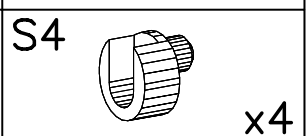

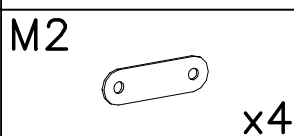

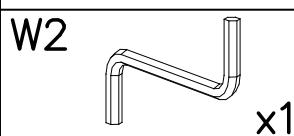

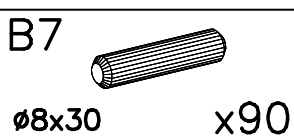
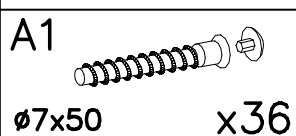
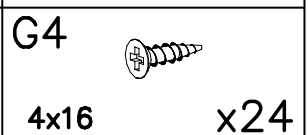
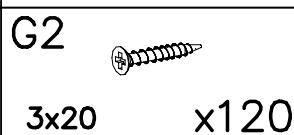
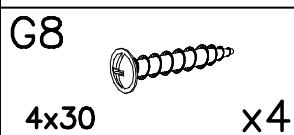
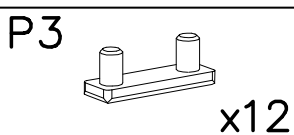
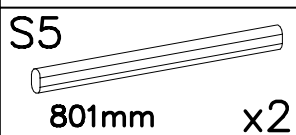
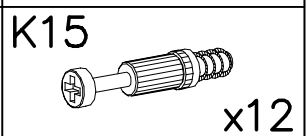
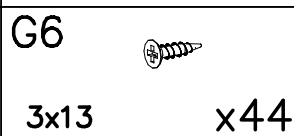
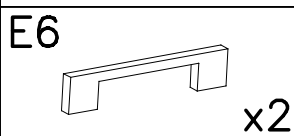
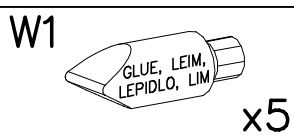
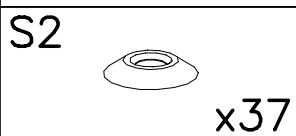
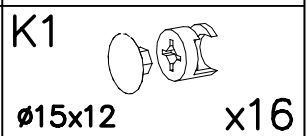
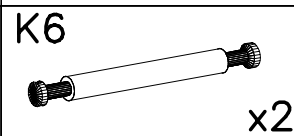
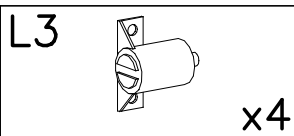
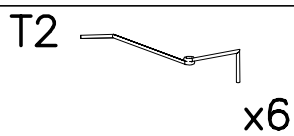
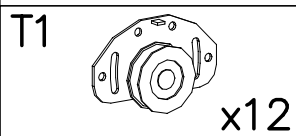
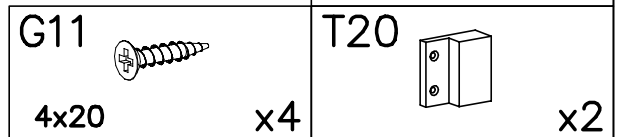
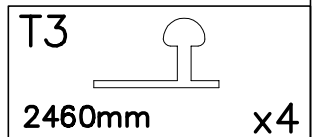
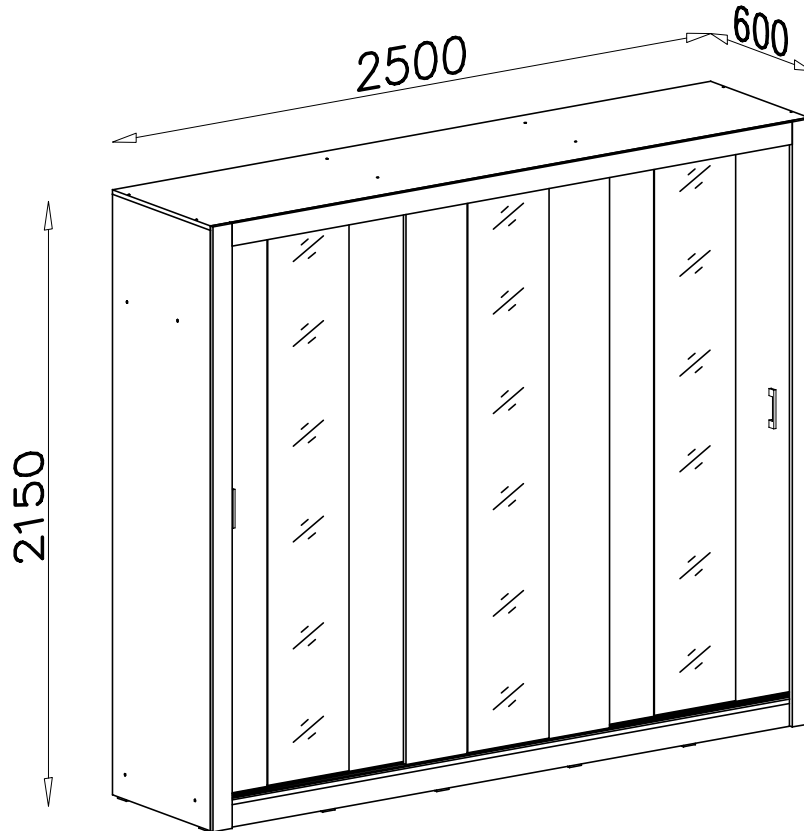
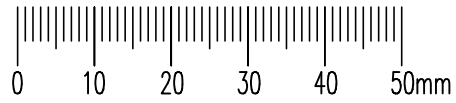
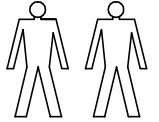
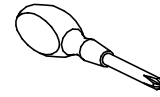
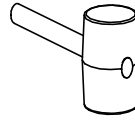
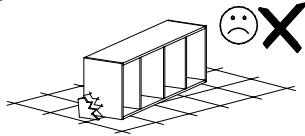
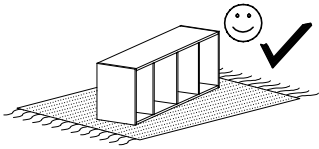
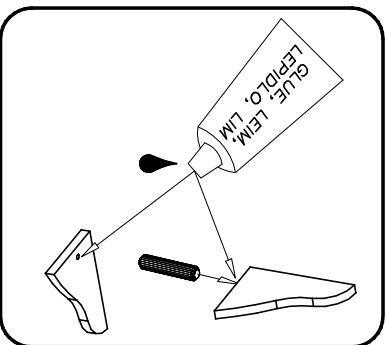
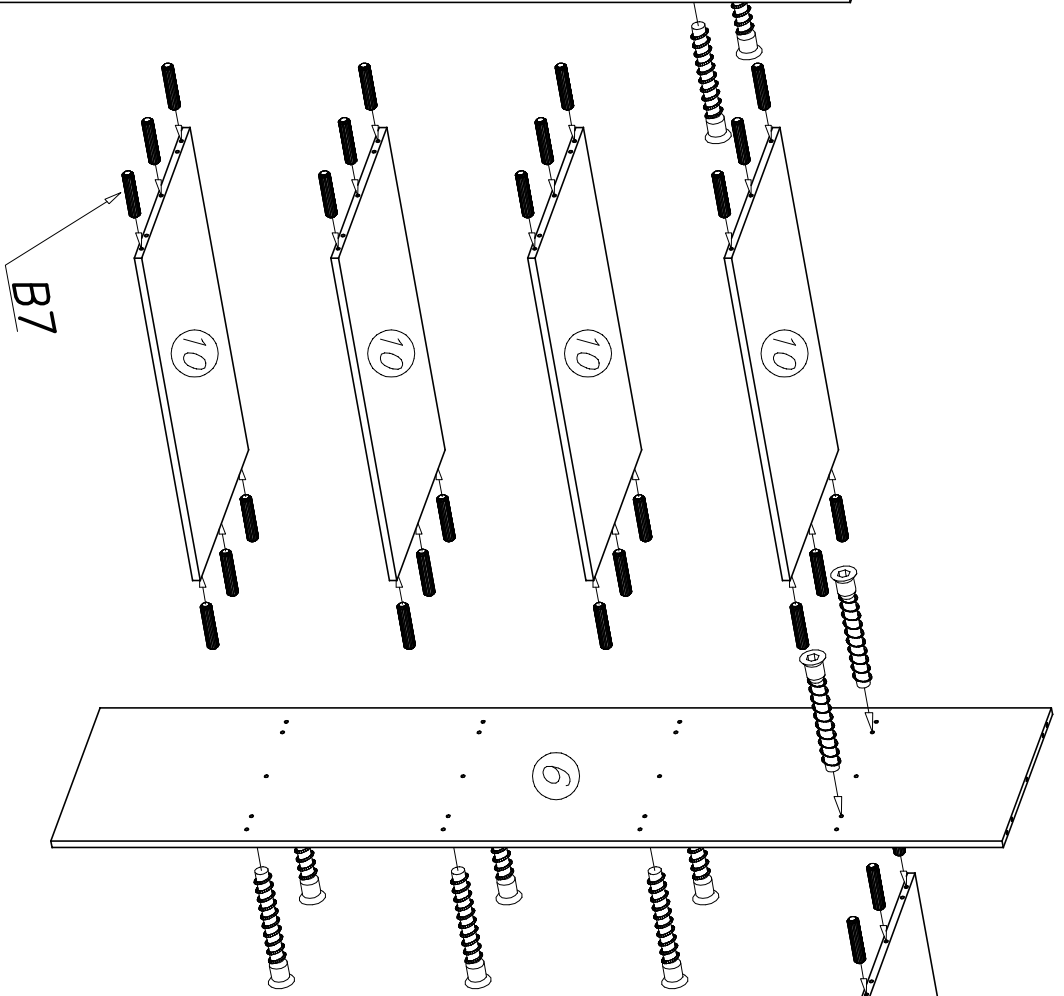
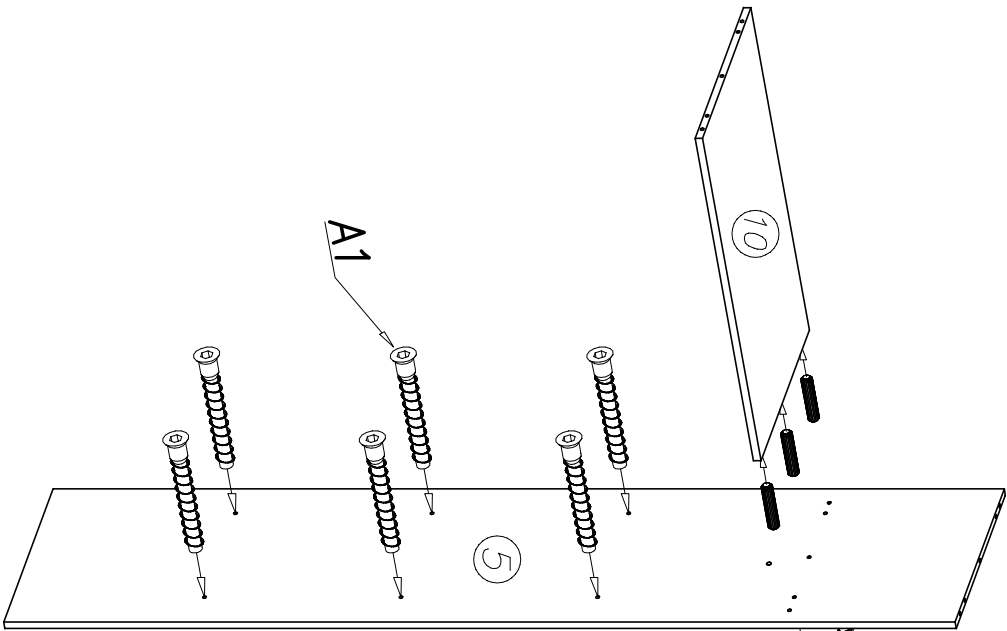
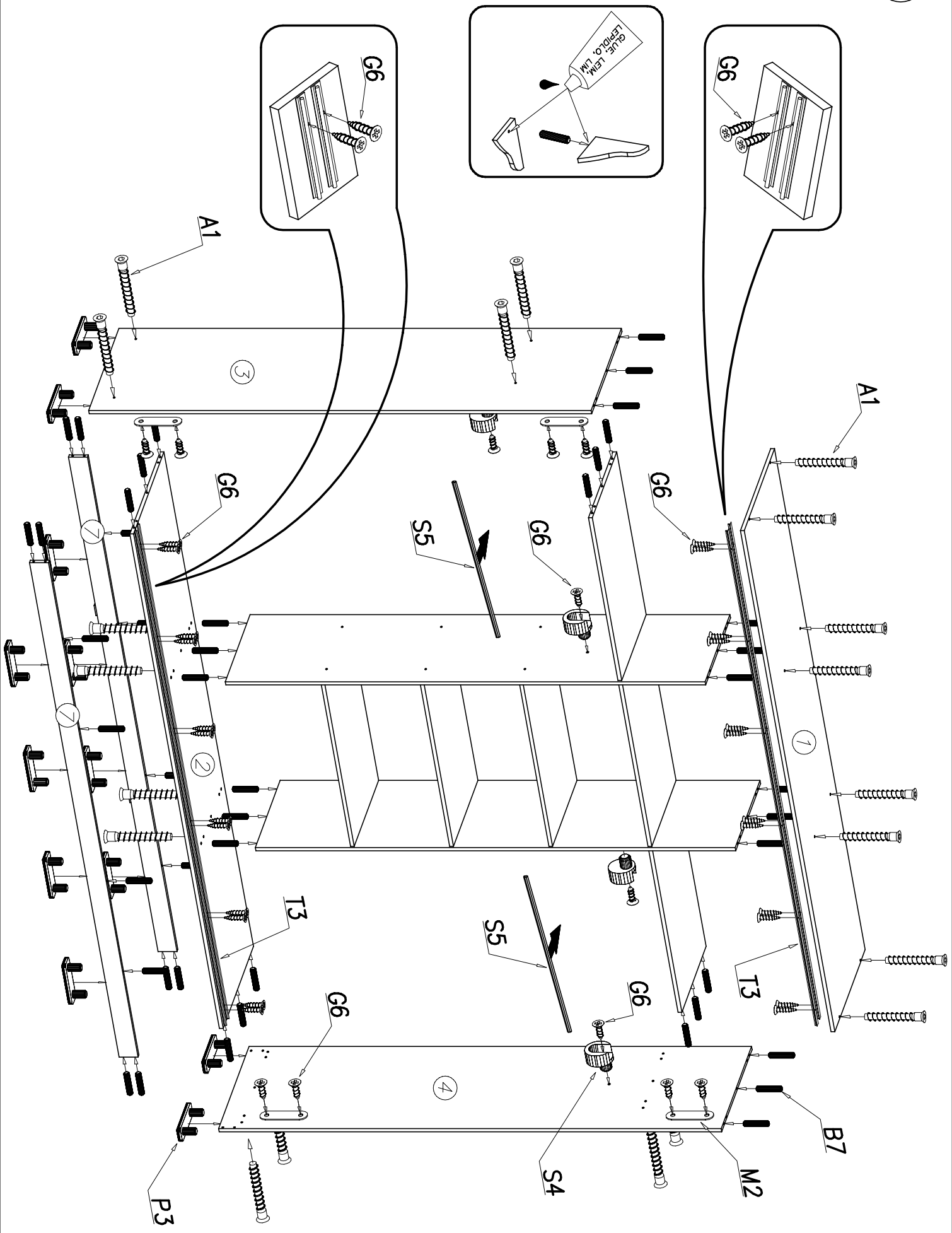
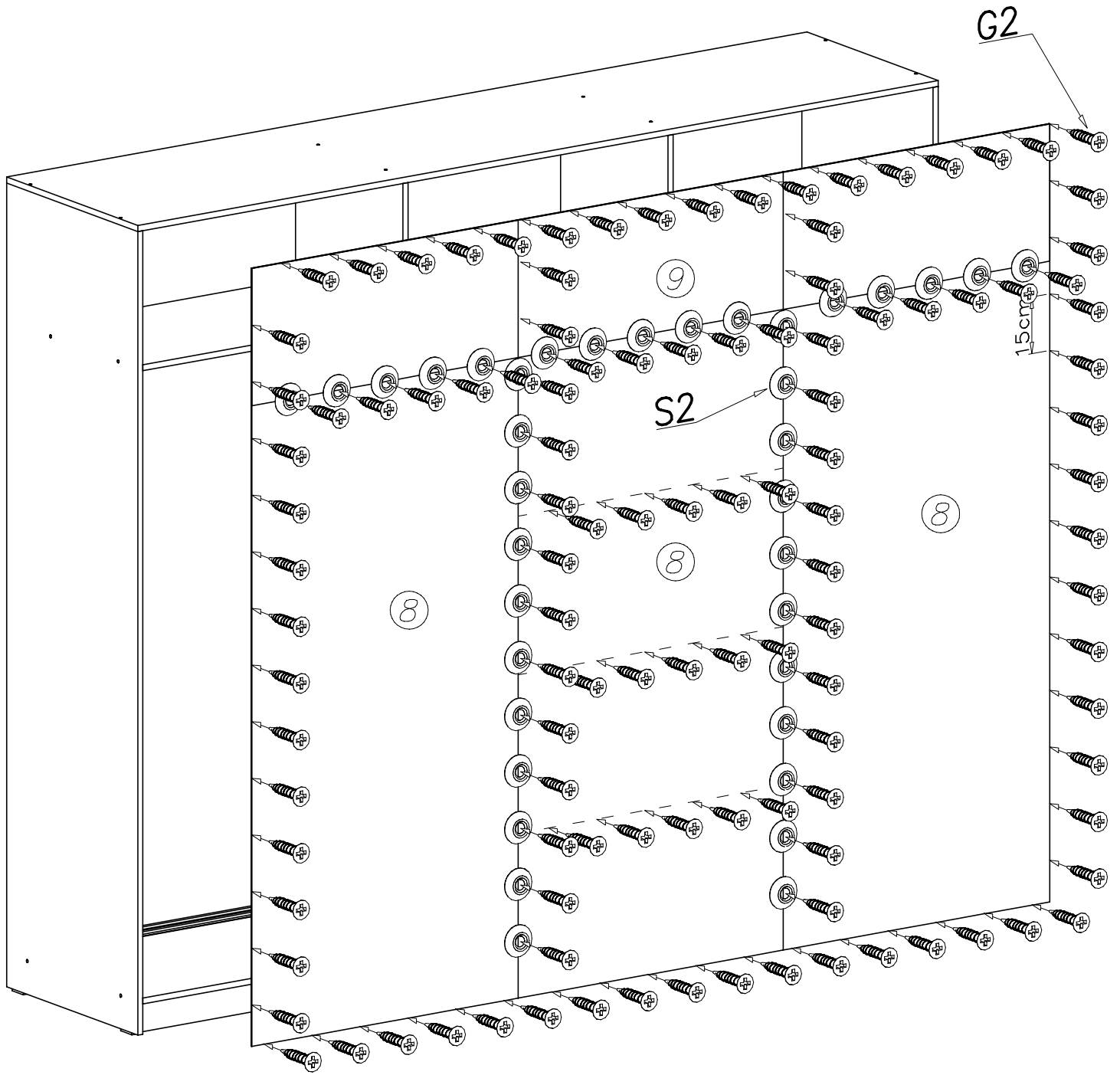

IV

E6

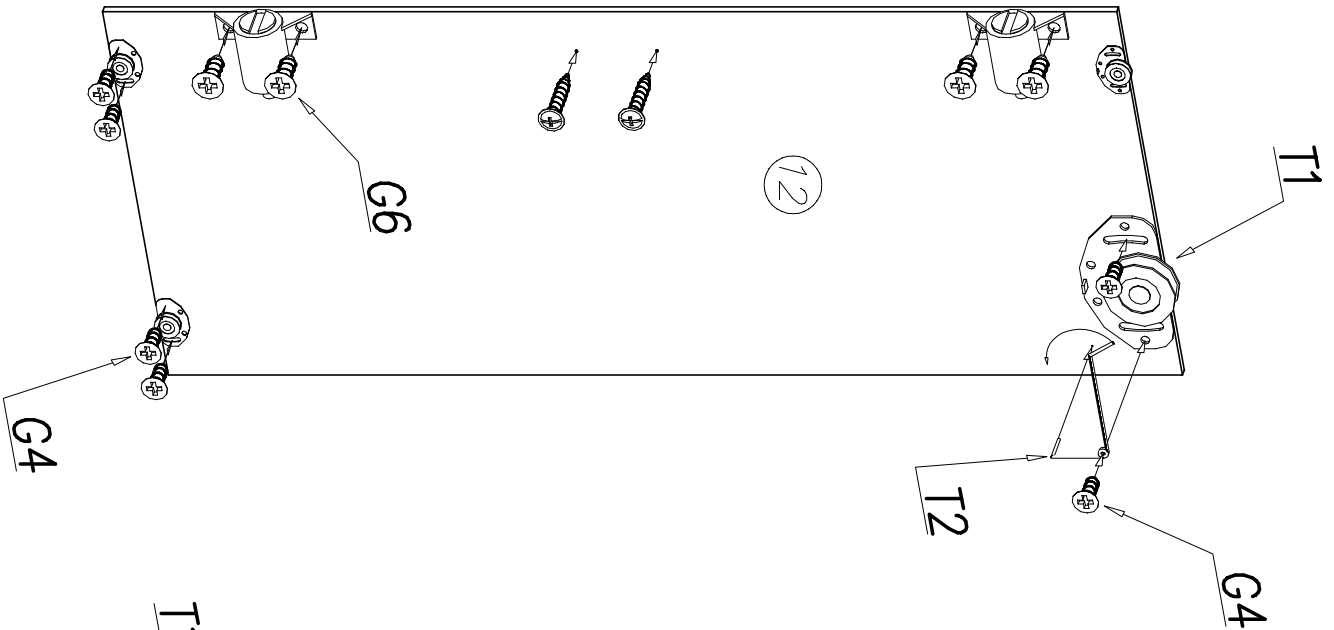

12

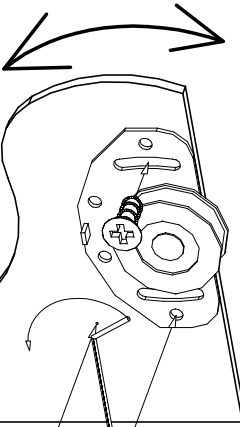

13

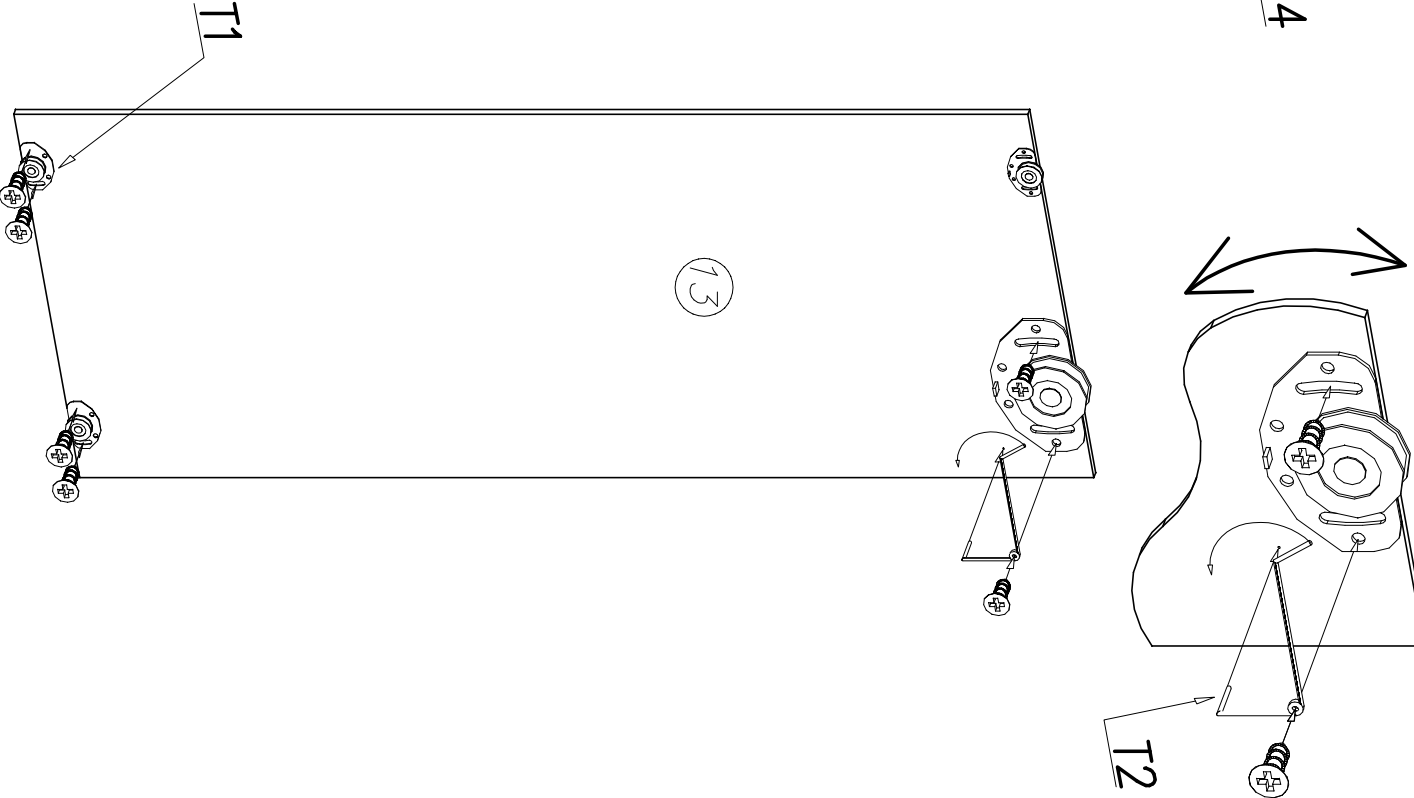

11

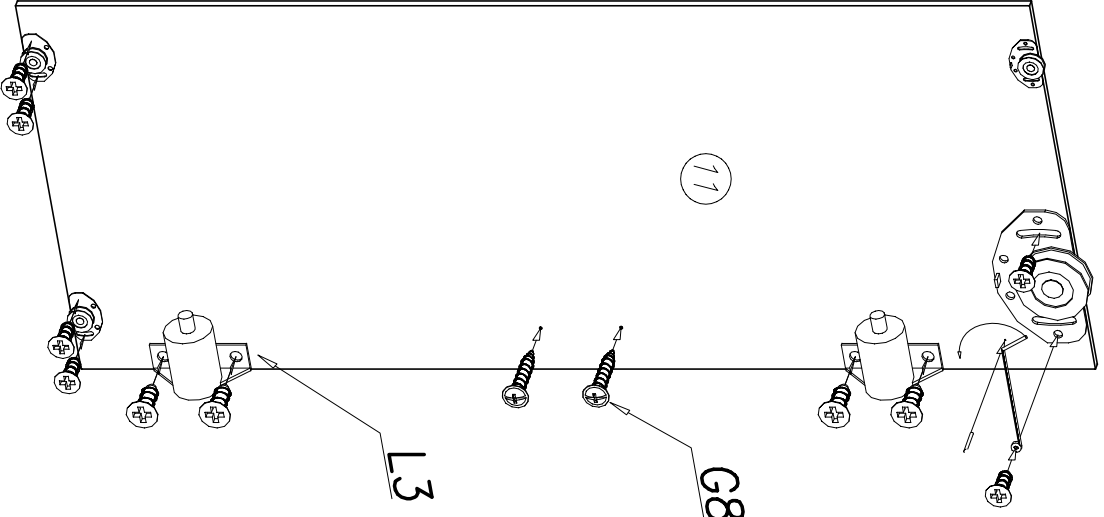

L3

G8

V

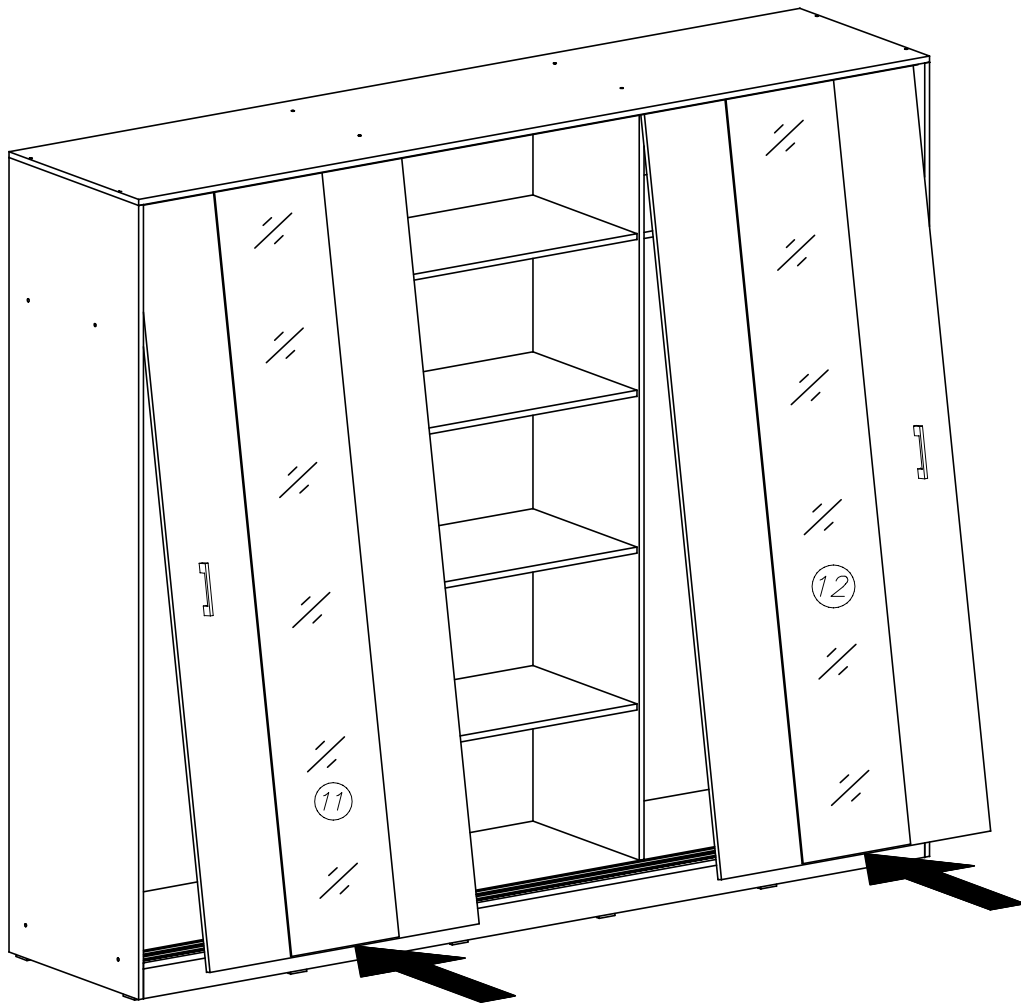

VI

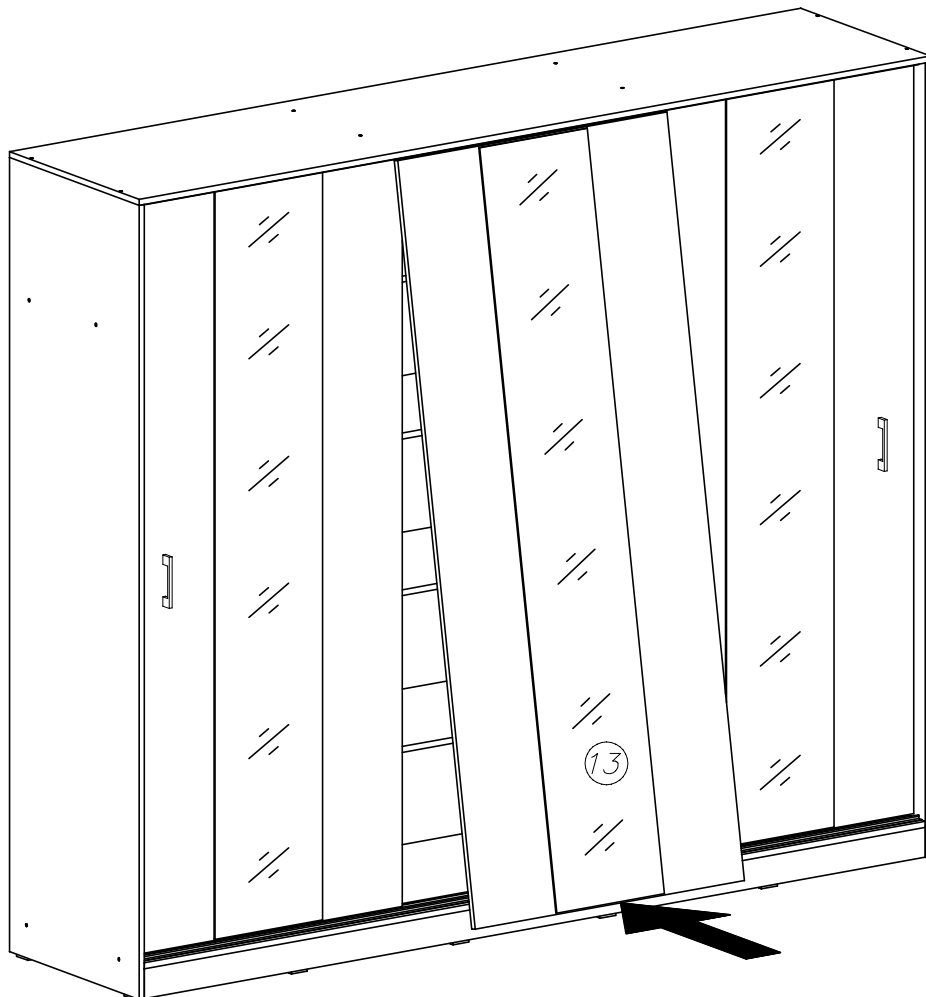

VII

