

KORA 10

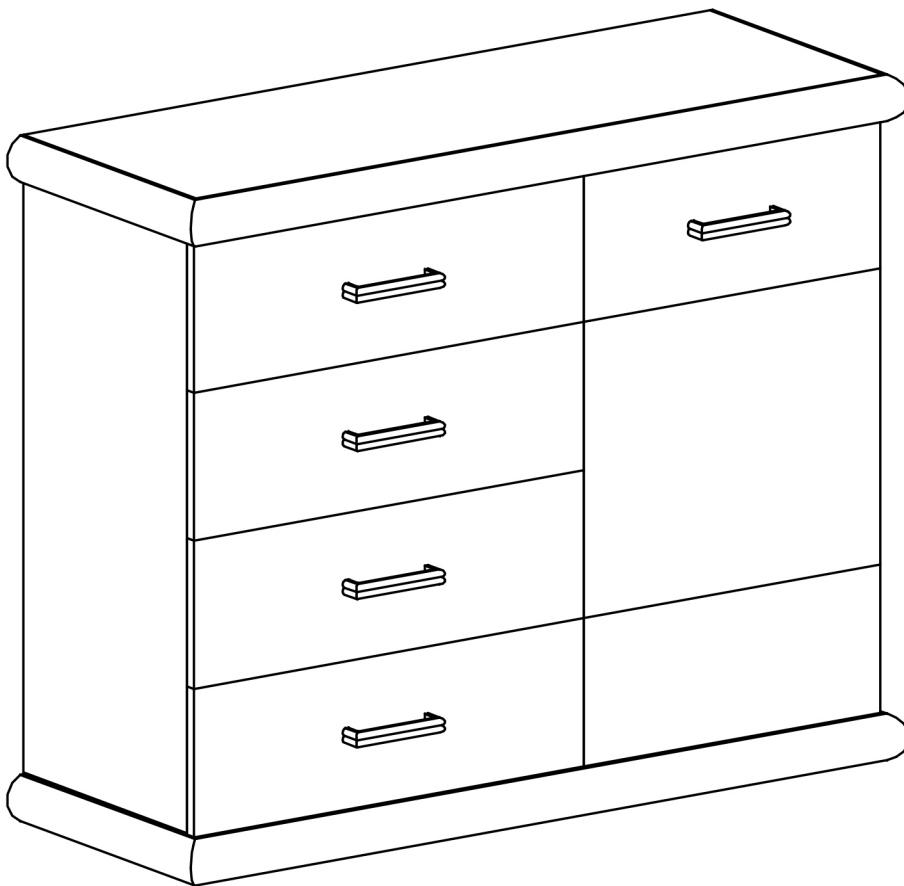

Nr	D[mm]	S[mm]	G[mm]	
1	1155	450	65	1
2	1155	450	65	1
3	830	410	16	1
4	830	410	16	1
5	830	410	16	1
6	1088	852	2,5	1
7	432	380	16	1
8	770	450	16	1
9	590	355	2,5	4
10	350	150	16	8
11	560	150	16	4
12	635	190	16	4

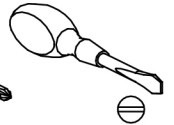
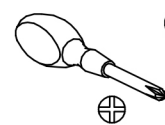
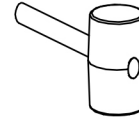
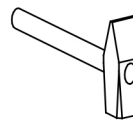
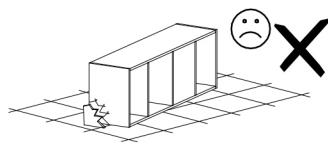
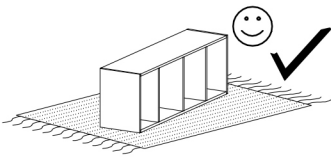
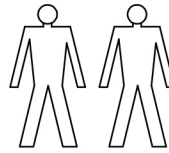
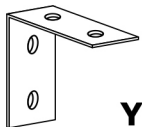

Y - 1 St.

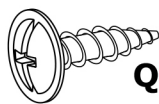

Q - 2 St.
3,5x16 mm

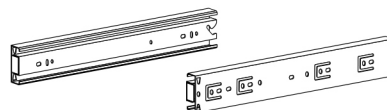

T - 4 Kpl.



X1 - 8 St.

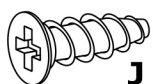

J - 32 St.
5x13 mm

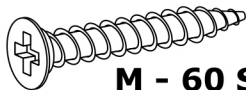

M - 60 St.
3x30 mm

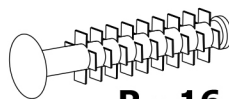

P - 16 St.

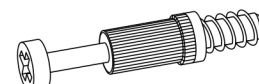

K - 12 St.



L - 12 St.

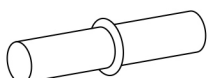

S - 4 St.

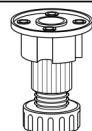

F - 5 St.



U - 5 St.

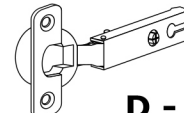

D - 2 St.

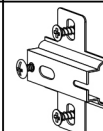

C - 2 St.



E - 50 St.

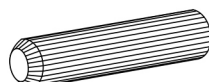

B - 28 St.

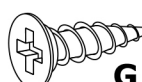

G - 24 St.
3,5x16 mm

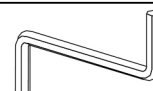

Z - 1 St.

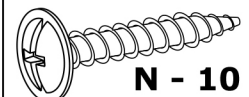

N - 10 St.
4x27 mm

I

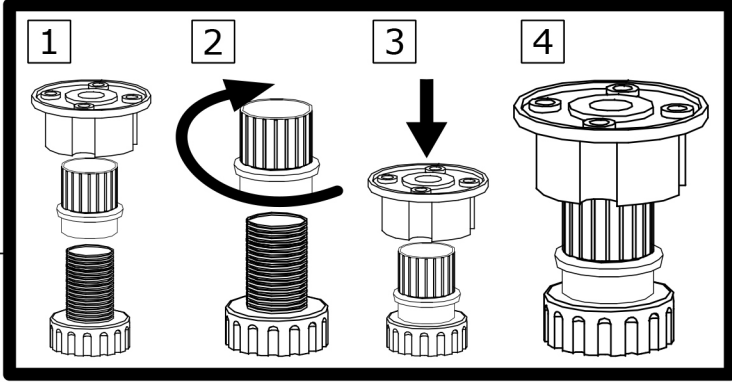
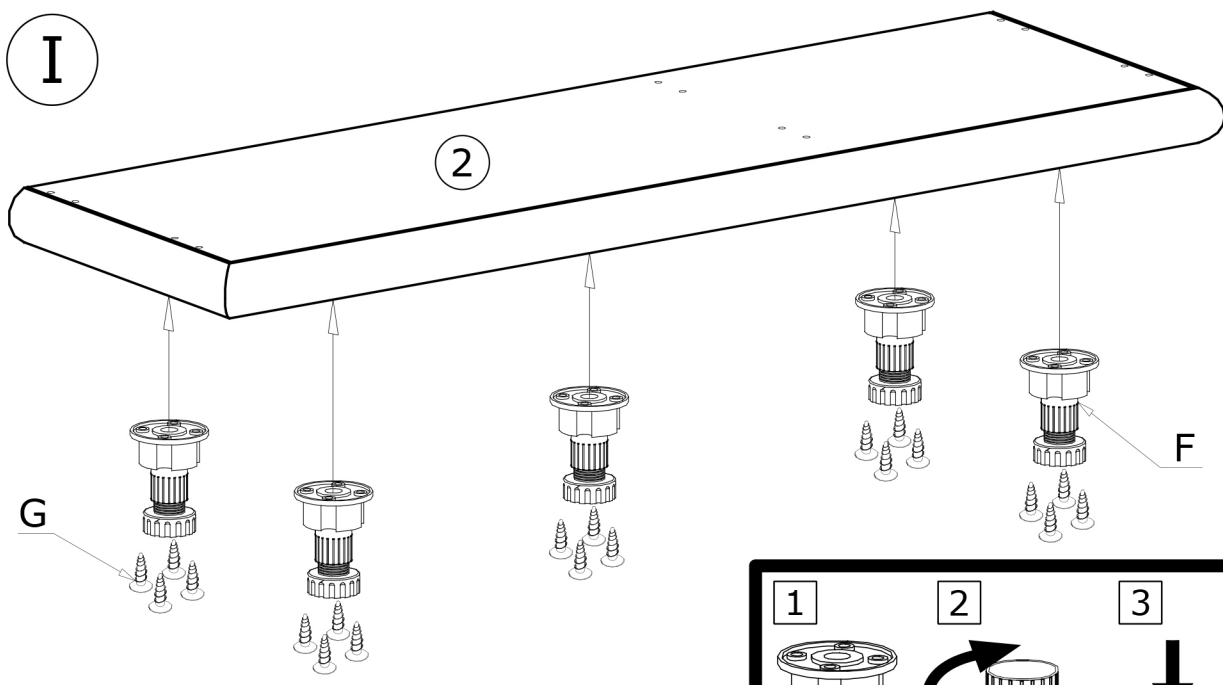

II

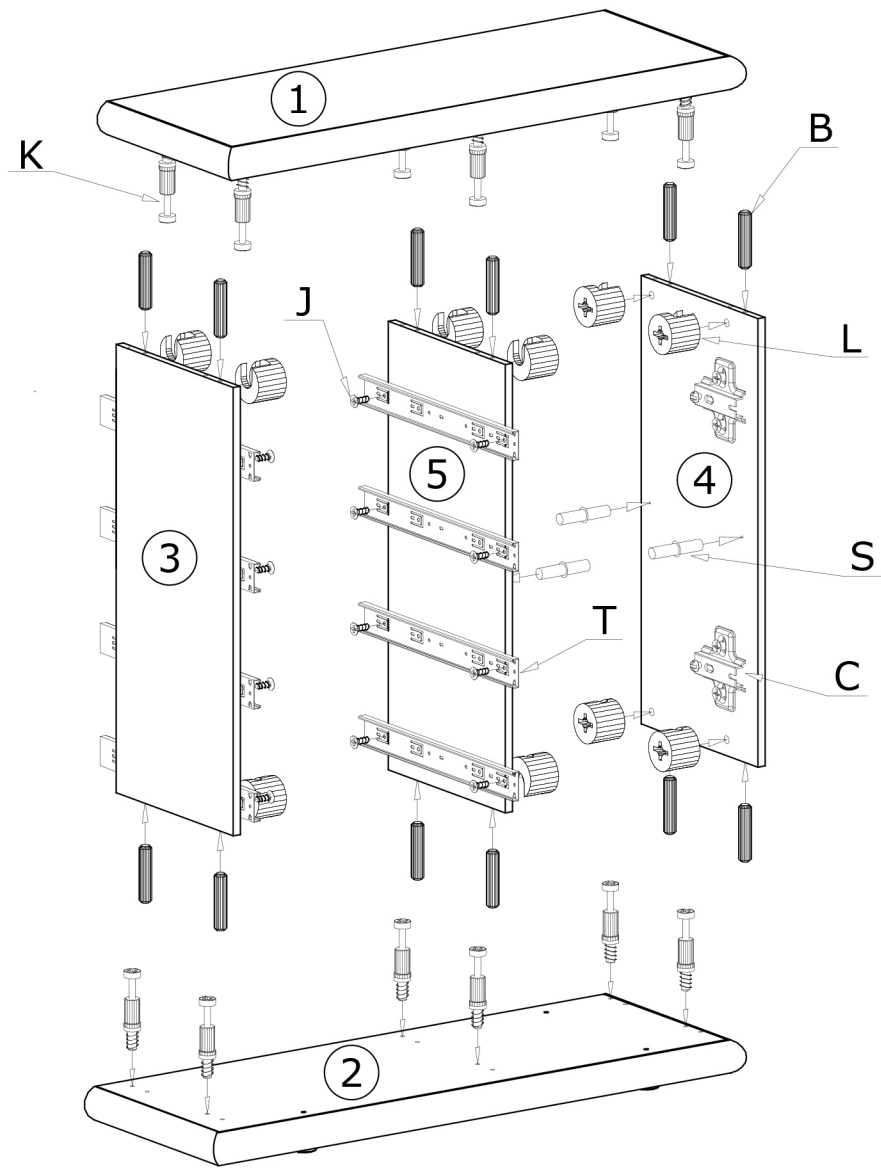

III

50X 

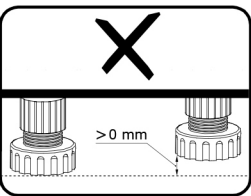
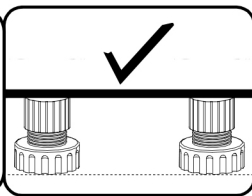
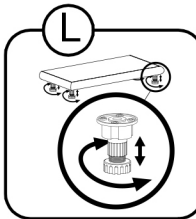
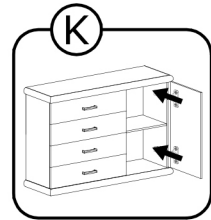
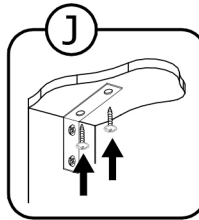
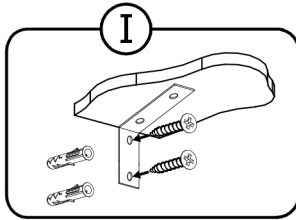
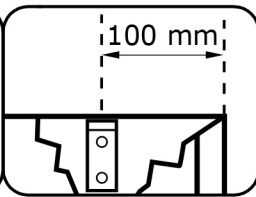
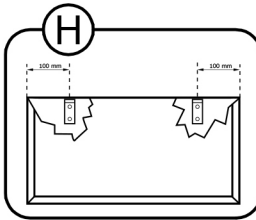
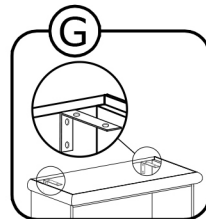
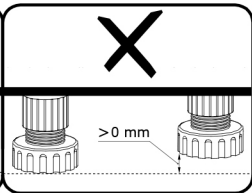
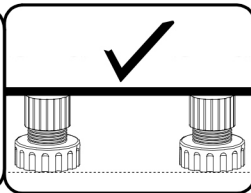
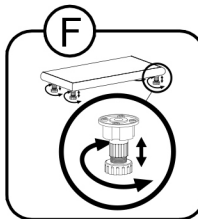
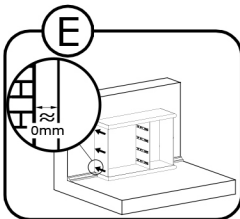
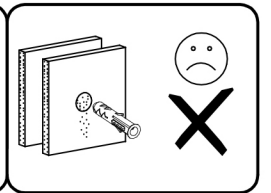
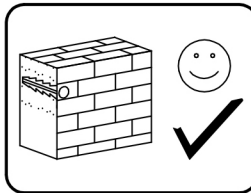
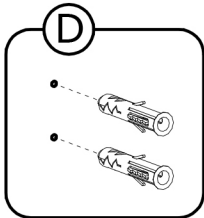
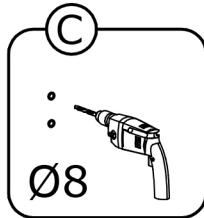
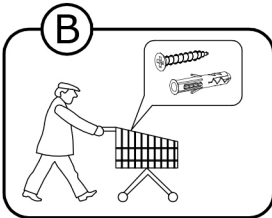
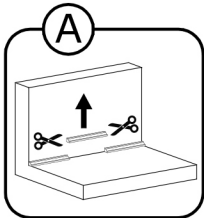
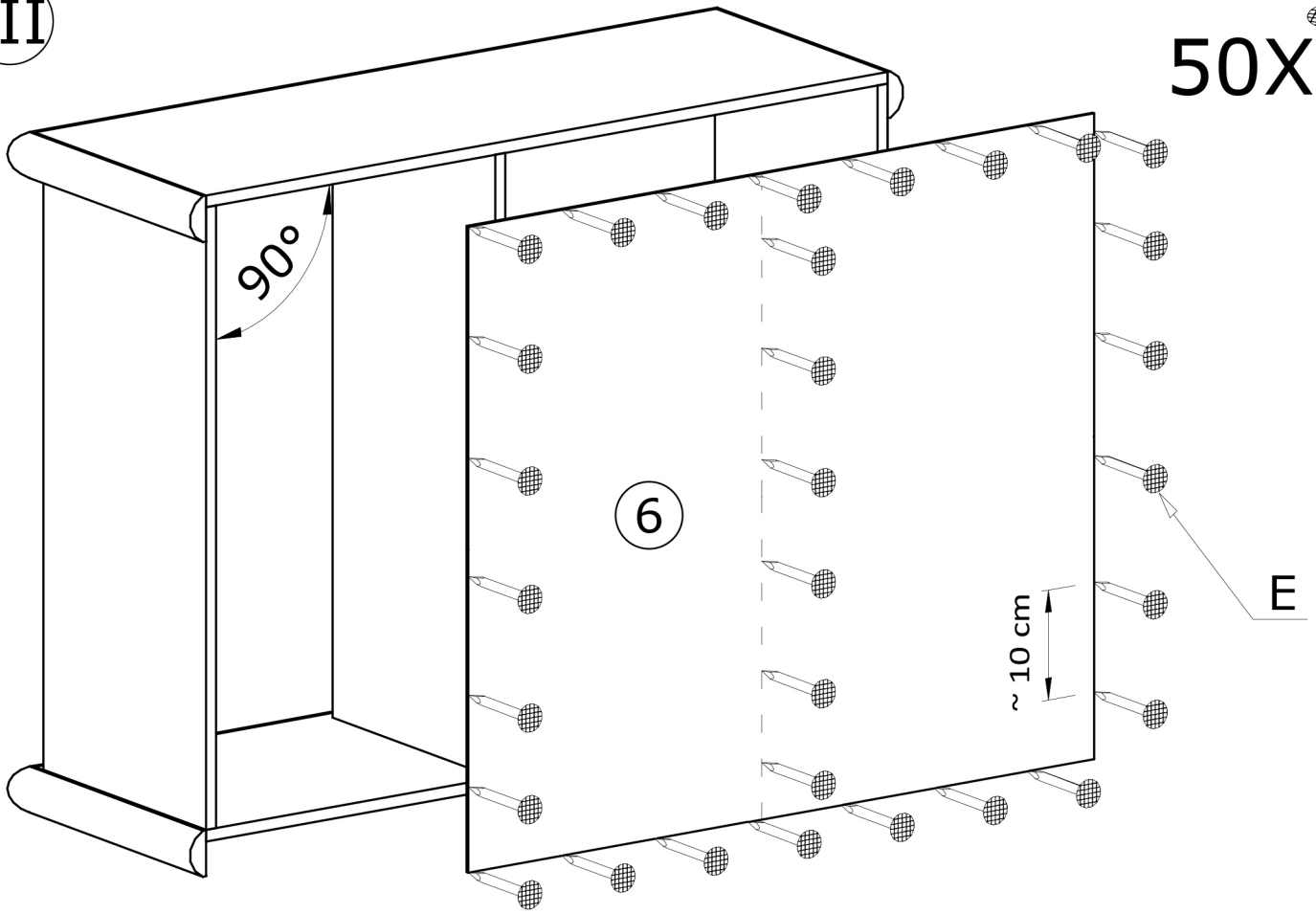

IV

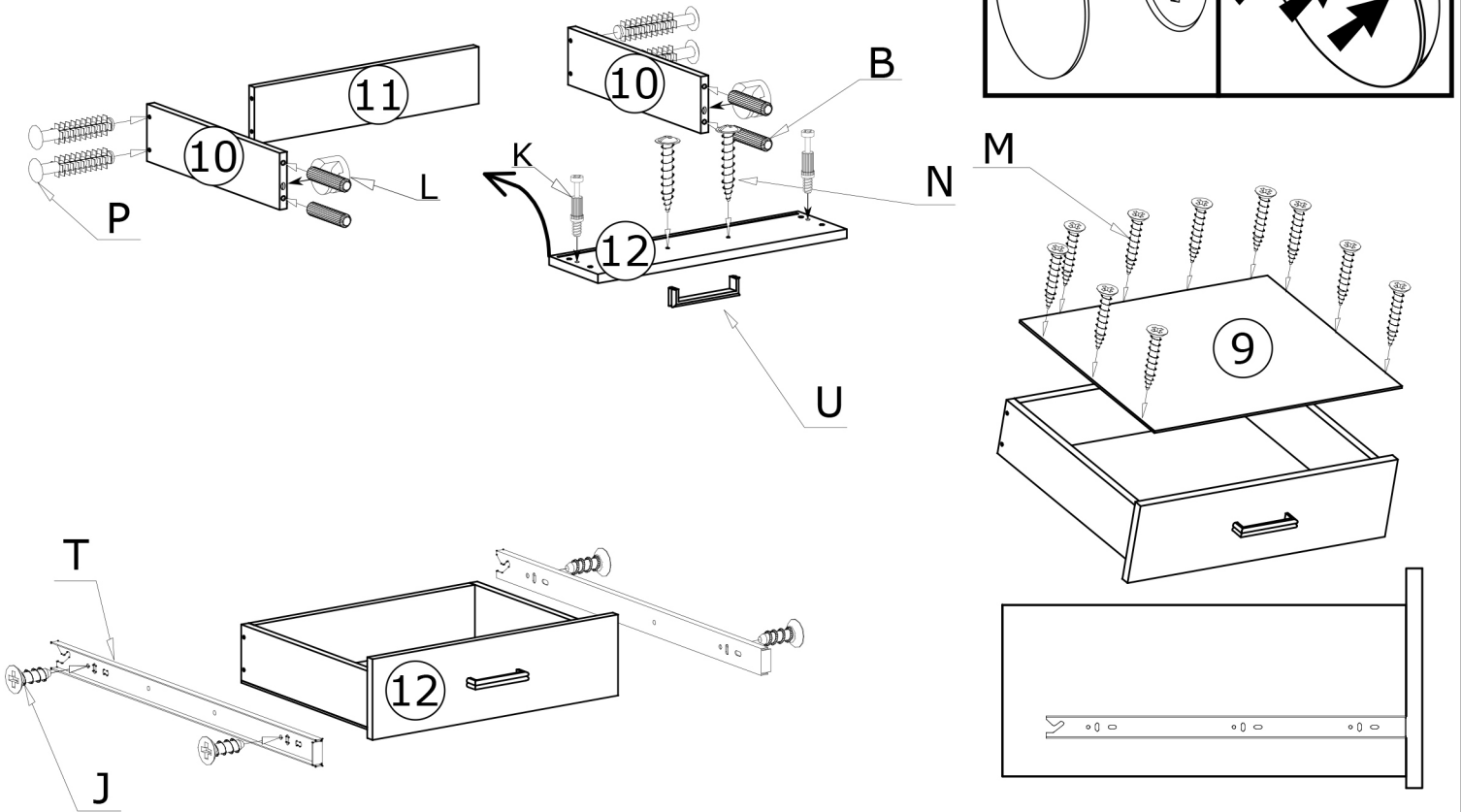

V

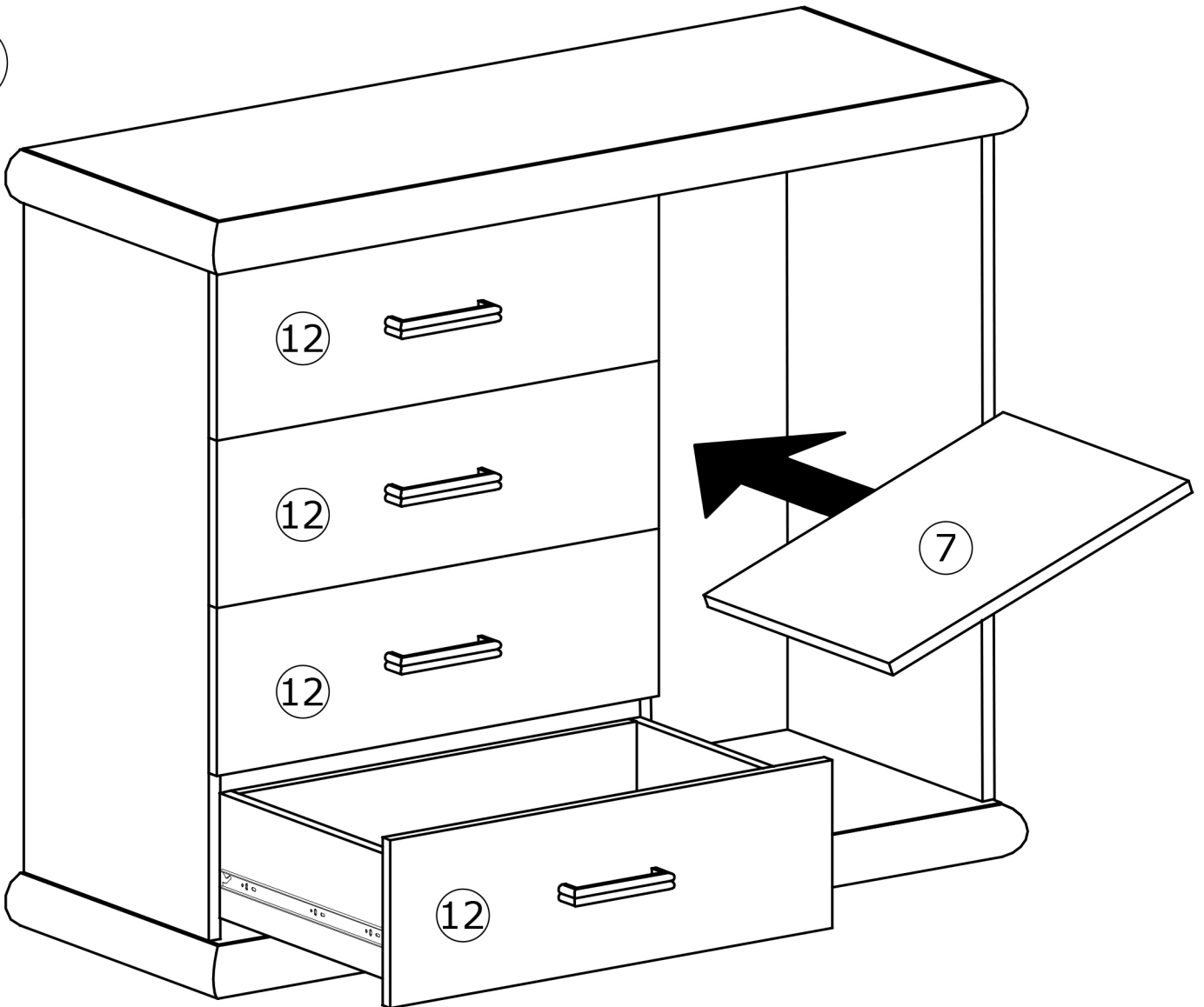

VI

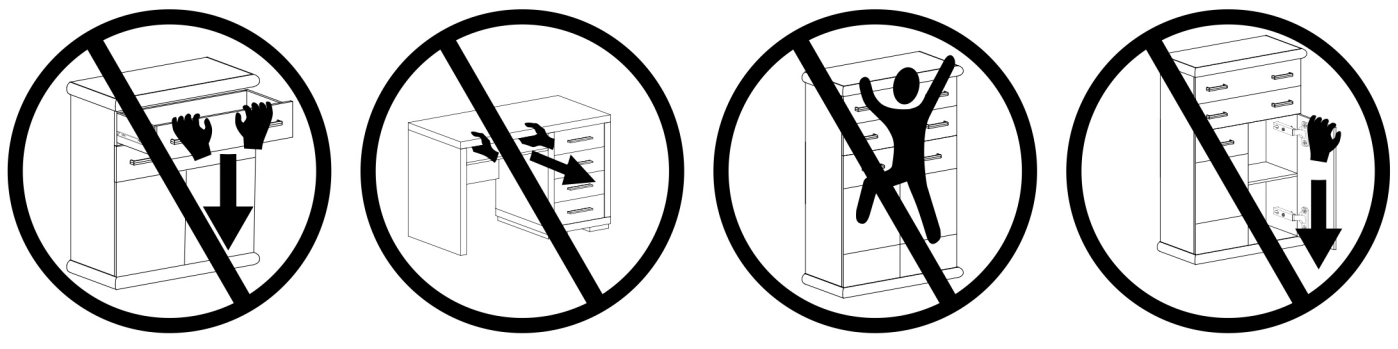
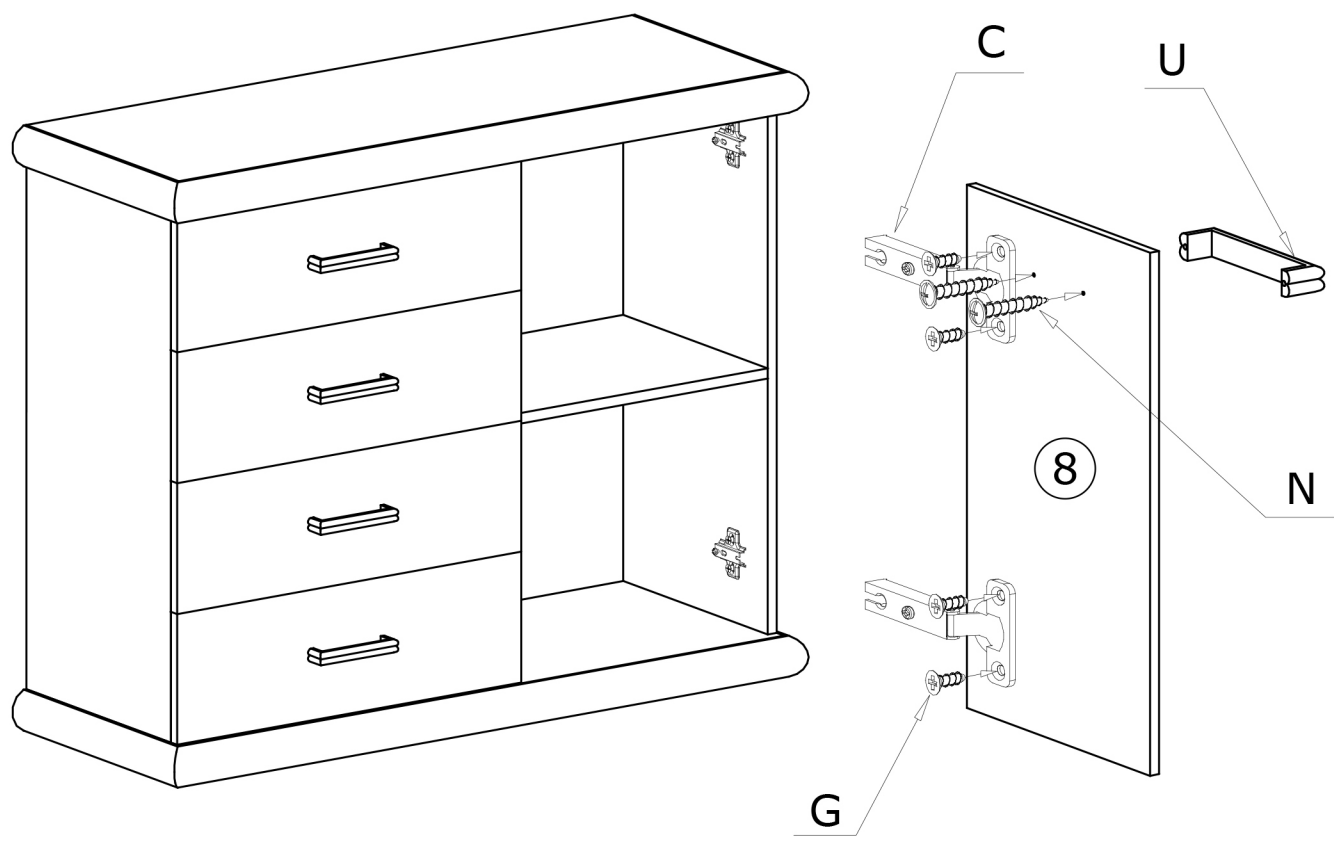

1

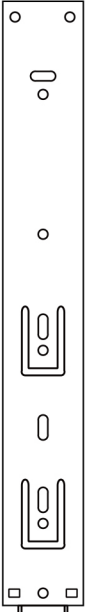

2

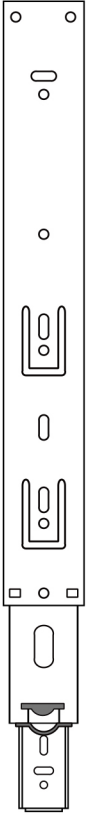

3



4

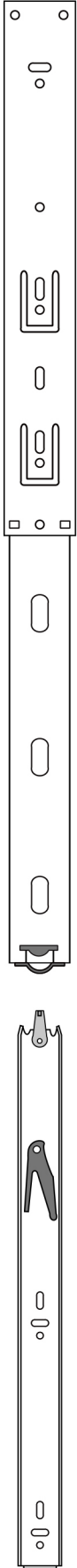

PL

UWAGA!!!

MONTOWANIE USZKODZONYCH ELEMENTÓW POWODUJE UTRATĘ GWARANCJI

UWAGA!!!

MEBEL ZAWIERA ELEMENTY DREWNIANE

W PRZYPADKU REKLAMACJI PROSZĘ PODAĆ NUMER PAKOWACZA ZNAJDUJĄCY SIĘ NA KARTONIE
ODCIĘŃ DREWNA I UKŁAD SŁOI MOGĄ NIEZNACZNIE ODBIEGAĆ
OD PREZENTOWANYCH NA ZDJĘCIACH KATALOGOWYCH

CZ

UPOZORNĚNÍ!!!

MONTÁŽ POŠKOZENÝCH KOMPONENTŮ RUŠÍ PLATNOU ZÁRUKU

UPOZORNĚNÍ!!!

NÁBYTEK OBSAHUJE DŘEVĚNÉ PRVKY

V PŘÍPADĚ REKLAMACE UVEĎTE PROSÍM ČÍSLO BALIČE, KTERÉ NAJDETE NA KRABICI
ODSTÍN A KRESBA DŘEVA SE MOHOU VÝRAZNĚ LIŠIT
OD TĚCH ZOBRAZENÝCH NA KATALOGOVÝCH FOTOGRAFIÍCH

DE

BEACHTUNG!!!

DER EINBAU BESCHÄDIGTER KOMPONENTEN SCHLIESST EINE GÜLTIGE GEWÄHRLEISTUNG AUS

BEACHTUNG!!!

MÖBEL ENTHALTEN HOLZELEMENTE

IM FALL EINER REKLAMATION GEBEN SIE BITTE DIE PAKETNUMMER AN,
DIE SIE AUF DEM KARTON FINDEN
HOLZSCHATTIERUNG UND HOLZZEICHNUNG KÖNNEN UNTERSCHIEDLICH
VON DEN AUF DEN KATALOGFOTOS GEZEIGTEN ABWEICHEN

HR

PAŽNJA!!!

INSTALACIJA OŠTEĆENIH KOMPONENTI ZA POSLJEDICU IMA GUBITAK JAMSTVA

PAŽNJA!!!

NAMJEŠTAJ SADRŽI DRVENE ELEMENT

U SLUČAJU REKLAMACIJE, MOLIMO NAVESTI BROJ PAKIRANJA KOJI SE NALAZI NA KUTIJI
NIJANSA DRVETA I RASPORED GODOVA MOGU MINIMALNO
ODUDARATI OD ONIH NA KATALOŠKIM FOTOGRAFIJAMA

HU

FIGYELEM!!!

SÉRÜLT ALKATRÉSZEK BEÉPÍTÉSE ESETÉN A GARANCIA ÉRVÉNYÉT VESZTI

FIGYELEM!!!

A BÚTOROK FA ELEMÉKET TARTALMAZNAK

REKLAMÁCIÓ ESETÉN KÉRJÜK, ADJA MEG A DOBOZON TALÁLHATÓ CSOMAGOLÁSI SZÁMOT
A FA ÁRNYALATA ÉS A CSOMÓK ELRENDEZÉSE
JELENTŐSEN ELTÉRHET A KATALÓGUSBAN SZEREPLŐ KÉPEKTŐL

SK

UPOZORNENIE!!!

INŠTALÁCIU POŠKODENÝCH KOMPONENTOV SA RUŠÍ ZÁRUKA

UPOZORNENIE!!!

NÁBYTOK OBSAHUJE DREVENÉ PRVKY

V PRÍPADE REKLAMÁCIÍ UVEĎTE ČÍSLO BALENIA NÁJDENÉ NA KRABICI
ODTIEŇ DŘEVA A USPORIADANIE UZLOV
SA MÔŽE VÝRAZNE LIŠIŤ OD KATALÓGOVÝCH OBRÁZKOV

SR

PAŽNJA!!!

MONTAŽA OŠTEĆENIH DELOVA DOVODI DO GUBITKA GARANCIJE

PAŽNJA!!!

NAMEŠTAJ SADRŽI DRVENE DELOVE

U SLUČAJU REKLAMACIJA MOLIMO DA DOSTAVITE PAKER BROJ KOJI SE NALAZI NA KARTONU
NIJANSA BOJE DRVETA I RASPORED SLOJEVA MOGU NEZNATNO
DA SE RAZLIKUJU OD PREZENTOVANIH NA SLIKAMA U KATALOGU